

2007 EDITION

ANSI/AF&PA PWF-2007

Approval Date: AUGUST 7, 2007

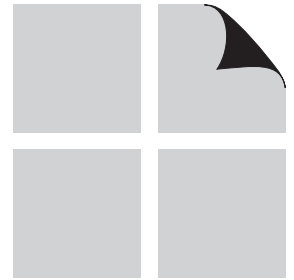

PWF

PERMANENT WOOD FOUNDATION DESIGN SPECIFICATION

WITH COMMENTARY

**American
Forest &
Paper
Association**

American Wood Council

Updates and Errata

While every precaution has been taken to ensure the accuracy of this document, errors may have occurred during development.

Updates or Errata are posted to the American Wood Council website at www.awc.org.

Technical inquiries may be addressed to awcinfo@afandpa.org.

The American Wood Council (AWC) is part of the wood products group of the American Forest & Paper Association (AF&PA). AF&PA is the national trade association of the forest, paper, and wood products industry, representing member companies engaged in growing, harvesting, and processing wood and wood fiber; manufacturing pulp, paper, and paperboard products from both virgin and recycled fiber, and producing engineered and traditional wood products. For more information see www.afandpa.org.

2007 Edition

ANSI/AF&PA PWF-2007
Approval Date: AUGUST 7, 2007

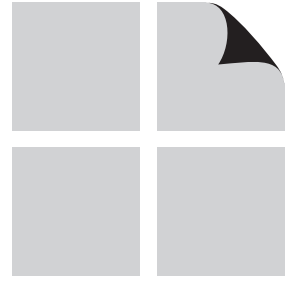

P W F

PERMANENT WOOD FOUNDATION DESIGN SPECIFICATION

WITH COMMENTARY

Permanent Wood Foundation Design Specification with Commentary 2007 Edition

First Web Version: August 2007

Second Web Version: March 2009

ISBN: 0-9786245-8-0

Copyright © 2007, 2009 by American Forest & Paper Association, Inc.

All rights reserved. No part of this publication may be reproduced, distributed, or transmitted in any form or by any means, including, without limitation, electronic, optical, or mechanical means (by way of example and not limitation, photocopying, or recording by or in an information storage retrieval system) without express written permission of the American Forest & Paper Association, Inc. For information on permission to copy material, please contact:

Copyright Permission

AF&PA American Wood Council

1111 Nineteenth St., NW, Suite 800

Washington, DC 20036

email: awcinfo@afandpa.org

Produced in the United States of America

FOREWORD

Permanent Wood Foundation (PWF) systems are intended for light frame construction including residential buildings. The realization of full performance potential requires proper attention to design, fabrication, and installation of the foundation. This document primarily addresses structural design requirements.

The Permanent Wood Foundation is a load-bearing wood-frame wall and floor system designed for both above and below-grade use as a foundation for light frame construction. The PWF specifications are based on information developed cooperatively by the wood products industry and the U.S. Forest Service, with the advice and guidance of the Department of Housing and Urban Development's Federal Housing Administration and utilizing research findings of the National Association of Home Builders Research Center. The system combines proven construction techniques along with proven below-grade moisture control technology.

Stress-graded lumber framing and plywood sheathing in the system shall be engineered to support lateral soil pressures as well as dead, live, snow, wind, and seismic loads.

Moisture control measures based on foundation engineering, construction practice, and building materials technology are employed to achieve dry and comfortable living space below-grade. The most important of these moisture control measures is a granular drainage layer surrounding the lower part of the basement that conducts ground water to a positively drained sump, preventing hydrostatic pressure on the basement walls or floor. Similarly, moisture reaching the upper part of the basement foundation wall is deflected downward to the gravel drainage system by polyethylene sheeting, or by the treated plywood wall itself. The result is a dry basement space that is readily insulated and finished for maximum comfort and conservation of energy, utility, and use of space.

Wood foundation sections of lumber framing and plywood sheathing may be factory fabricated or constructed at the job site.

American Forest & Paper Association

TABLE OF CONTENTS

Section/Title	Page	Section/Title	Page
1 GENERAL REQUIREMENTS	1	4 ENVIRONMENTAL CONTROL	11
1.1 Scope	2	4.1 Design for Dryness	12
1.2 Conformance With Standards	2	4.2 Design for Climate Control	13
1.3 Terminology	2	5 STRUCTURAL DESIGN	15
1.4 Notation	3	5.1 General	16
2 MATERIALS	5	5.2 Material Design Standards	16
2.1 Framing	6	5.3 Design Loads and Design Methodology	16
2.2 Sheathing	6	5.4 PWF Wall Design	18
2.3 Preservative Treatment	6	5.5 Footing Design	22
2.4 Connections In Preservative-Treated Wood	7	5.6 Basement Floor Design	24
2.5 Aggregate for Footings and Fill	7	5.7 Design of Framing Around Openings	24
2.6 Caulking Compound	7	REFERENCES	25
2.7 Polyethylene Sheeting	7		
2.8 Polyethylene Sheeting Adhesive	8		
3 SOIL: TYPES, STRUCTURAL PERFORMANCE, DRAINAGE	9		
3.1 Soil Types	10		
3.2 Soil Structure Characteristics	10		

LIST OF FIGURES

Figure	Page
1 PWF Exterior Basement Wall Showing Location of Vapor Barrier With Vented Air Space	13
2 PWF Exterior Basement Wall Showing Location of Vapor Barrier with no Vented Air Space	14
3 Pressure Diagram Used to Calculate Bending Moment, Shear, and Deflection in Foundation Walls with Basement Resisting Lateral Soil Load.	17
4 Pressure Diagram Used to Calculate Bending Moment, Shear, and Deflection in Foundation Walls with Crawl Space Resisting Lateral Soil Load.	17
5 Basement Wall Anchorage to Resist Wind Uplift.....	21
6 Crawl Space Wall Anchorage to Resist Wind Uplift.....	21

COMMENTARY TABLE OF CONTENTS

Section/Title	Page	Section/Title	Page
C1 GENERAL REQUIREMENTS	29	C4 ENVIRONMENTAL CONTROL ...	32
C1.1 Scope	29	C4.1 Design for Dryness	32
C1.2 Conformance with Standards	29	C4.2 Design for Climate Control	32
C1.4 Notation	29	C5 STRUCTURAL DESIGN	33
C2 MATERIALS	30	C5.2 Material Design Standards	33
C2.2 Sheathing	30	C5.3 Design Loads and Design Methodology	33
C2.3 Preservative Treatment	30	C5.4 PWF Wall Design	34
C2.5 Aggregate for Footings and Fill	30	C5.5 Footing Design	42
C3 SOIL: TYPES, STRUCTURAL PERFORMANCE, DRAINAGE ...	31	C5.6 Basement Floor Design	44
C3.2 Soil Structural Characteristics	31	REFERENCES	45

LIST OF COMMENTARY FIGURES

Figure	Page	Figure	Page
C4.2.1.2	Insulation of Exterior Walls in Crawl Space Construction..... 32	C5.4-9	Shear and Bending Moment for the Portion of PWF Stud Located Below Inside Backfill Height and Subjected to Lateral Forces Due to Both Outside and Inside Backfill. 39
C5.3	Typical Loads and Reactions in a Permanent Wood Foundation 33	C5.4.4.1	Framing Strap to Transfer Lateral Loads into Floor Joists 41
C5.4-1	Lateral Soil Load Distribution and Reactions for PWF Basement Wall Stud 34	C5.4.4.2	Concrete Slab to Resist Lateral Forces at the Bottom of a Crawl Space Wall 41
C5.4-2	Lateral Soil Load Distribution and Reactions for PWF Basement Wall Stud in Calculating Shear Forces 34	C5.4.5.1	Net Resultant of Forces Due to Differential Backfill Height..... 42
C5.4-3	Calculating Shear at a Section “x” in the PWF Stud 35	C5.5.2.2-1	Plywood Reinforcing Strip..... 42
C5.4-4	Calculating Bending Moment at a Section “x” in the PWF Stud..... 36	C5.5.2.2-2	Forces on Cantilevered Portion of Footing Plate 43
C5.4-5	Lateral Soil Load Distribution and Reactions for PWF Crawl Space Wall Stud..... 37	C5.5.3.2-1	Distribution of Axial Load from Wood Footing Plate 43
C5.4-6	Net Lateral Soil Load Distribution and Reactions for PWF Crawl Space Wall Stud..... 38	C5.5.3.2-2	Spread Footing using Alternating Layers of Wood Planks 44
C5.4-7	Calculating Shear at a Section “x” in the PWF Crawl Space Stud 38	C5.6.2.2	Blocking for PWF End Walls..... 44
C5.4-8	Shear and Bending Moment for the Portion of Crawl Space PWF Stud Located Above Inside Backfill Height and Subjected to Lateral Forces Due to Outside Backfill Only..... 39		

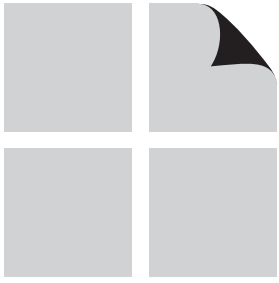

GENERAL REQUIREMENTS

1.1	Scope	2
1.2	Conformance With Standards	2
1.3	Terminology	2
1.4	Notation	3

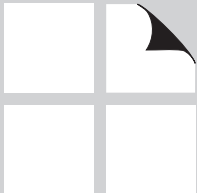

1.1 Scope

The basic design and construction requirements for permanent wood foundation (PWF) systems are set forth in this Permanent Wood Foundation Design Specification. Criteria for materials, preservative treatment, soil characteristics, environmental control, design loads, and structural design are included. Where requirements are based on nationally recognized standards and specifications, these standards and specifications are referenced without elaboration.

This Specification is not intended to preclude the use of materials, assemblies, structures, or designs not meeting the criteria herein, where it is demonstrated by analysis based on recognized theory, full scale or prototype loading tests, studies of model analogues, or extensive experience in use that the material, assembly, structure, or design will perform satisfactorily in its intended use.

1.2 Conformance With Standards

The quality of wood products and fasteners, and the design of supporting members and connections shall comply with the requirements of the building code under which the foundation is designed and the standards specified herein.

1.3 Terminology

ALLOWABLE STRESS DESIGN (ASD). A method of proportioning structural members and their connections such that computed stresses do not exceed specified allowable stresses when the structure is subjected to appropriate load combinations (also called working stress design).

BACKFILL HEIGHT. The height of soil backfill measured from the bottom of the stud to the exterior ground surface at any particular point. For a crawl space with a trenched footing, backfill height is the difference between exterior and interior ground surfaces at any particular point.

COMPOSITE FOOTING. Footing which is comprised of a treated wood footing plate and a granular drainage layer consisting of gravel, coarse sand, or crushed stone.

DEEP FROST PENETRATION. Frost penetrations that are typically in the range of 4 feet or greater.

END WALL. Exterior PWF wall oriented parallel to floor joists.

GRANULAR DRAINAGE LAYER. A continuous layer of gravel, crushed stone or coarse sand used to drain the bottom of the foundation and to distribute the load from the footing to the soil.

JACK STUD. A stud of less than full height that is fastened to a full height stud to support the end of a lintel or beam and to transfer vertical loads to the footing.

KNEE WALL. A less than full height wall used outside the main foundation wall to support brick or stone veneer or other loads.

LOAD AND RESISTANCE FACTOR DESIGN (LRFD). A method of proportioning structural members and their connections using load and resistance factors such that no applicable limit state is reached when the structure is subjected to required load combinations.

PLYWOOD. A wood structural panel comprised of plies of wood veneer arranged in cross-aligned layers. The plies are bonded with an exterior adhesive that cures on application of heat and pressure.

SIDE WALL. Exterior PWF wall oriented perpendicular to floor joists.

SILL. The horizontal member forming the bottom of the rough frame openings of windows.

STUB WALL. Relatively short bearing wall – usually approximately 3 ft in height, which is supported by a

footing plate and granular drainage layer and provides bearing support for walls and/or floor joists above.

PRESERVATIVE-TREATED WOOD. Wood impregnated under pressure with preservatives that reduce its susceptibility to deterioration. Preservative-treated wood used in permanent wood foundations shall be pressure treated with preservatives in accordance with AWWA U1: User Specification for Treated Wood: Commodity Specification A, Section 4.2 Lumber and Plywood for Permanent Wood Foundations; UC4B retention.

1.4 Notation

A_{fp} = area of wood footing plate, in. ²	M = ASD design bending moment in plywood footing plate, in.-lbs/ft (lineal foot of footing plate)
B_s = induced lateral load in diaphragm due to differential backfill, lbs per foot of length of wall perpendicular to the direction of the applied force	M_{panel} = maximum PWF plywood bending moment, in.-lbs/ft (lineal ft of plywood panel width)
$d_{footing}$ = depth of granular footing, in.	M_{stud} = maximum design bending moment in PWF stud, ft-lbs
d_{stud} = depth of PWF stud perpendicular to wall, in.	p = axial ASD design load, lbs/ft (lineal foot of footing plate)
E_{stud} = modulus of elasticity of PWF stud, psi	P = axial ASD design load, lbs
$F_{c,\perp}'$ = adjusted compression design value perpendicular to grain, psi	$q_{footing}$ = allowable bearing pressure between footing plate and gravel, sand, or crushed stone footing, psf
$F_{t,\perp}'$ = adjusted tension design value perpendicular to grain, psi	q_{soil} = induced bearing pressure on soil from footing, psf
F_v' = adjusted shear design value parallel to grain (horizontal shear), psi	R_B = reaction at bottom of PWF stud (top of bottom plate), lbs/ft (lineal foot of wall)
h = backfill height (from top of bottom plate to ground surface), ft	R_T = reaction at top of PWF stud (bottom of top plate), lbs/ft (lineal foot of wall)
h_r = backfill height on the side of the building opposite the side with greatest depth of backfill, ft	s = PWF stud spacing, in.
h_i = backfill height on inside of PWF crawl space wall: distance from top of bottom plate to ground surface, ft	t_{fp} = thickness of wood footing plate, in.
h_n = backfill height on the side of the building with greatest depth of backfill, ft	V_{stud} = design shear force in PWF stud, lbs
h_o = backfill height on outside of PWF crawl space wall: distance from top of bottom plate to ground surface, ft	W = width of rectangular-shaped building, ft
H = height of PWF wall (from top of bottom plate to bottom of top plate), ft	w_{bp} = width of bottom wall plate, in.
I_{stud} = moment of inertia of PWF stud, in. ⁴	$w_{footing}$ = width of granular footing, in.
l_{fp} = length of wood footing plate, in.	w_{fp} = width of wood or multi-ply plywood footing plate, in.
	x = location of maximum design bending moment in PWF stud (from top of bottom plate), ft
	x_{fp} = cantilever length of wood footing plate or multi-ply plywood footing plate, in.

WALK-OUT BASEMENT. Basement which typically has little or no backfill on one side (walk-out side) and high backfill on the opposite side of the building (or structure). Also referred to as DAYLIGHT basement.

WOOD FOOTING PLATE. In conjunction with the granular drainage layer, the wood footing plate distributes loads from the PWF wall to the undisturbed soil below.

Δ_{stud} = maximum out-of-plane long-term deflection in
PWF wall stud, in.

ω = design lateral soil load, lbs/ft² per foot of
depth

MATERIALS

2.1	Framing	6
2.2	Sheathing	6
2.3	Preservative Treatment	6
2.4	Connections in Preservative-Treated Wood	7
2.5	Aggregate for Footings and Fill	7
2.6	Caulking Compound	7
2.7	Polyethylene Sheeting	7
2.8	Polyethylene Sheeting Adhesive	8

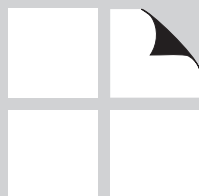

2.1 Framing

Framing used in the PWF system shall be lumber in accordance with USDOC PS 20 and shall bear the stamp of an approved grading agency or inspection bureau which participates in an accreditation program, such as the American Lumber Standard (ALS) program or equivalent.

2.2 Sheathing

Sheathing used in the PWF system shall be plywood manufactured with all softwood veneers, bonded with exterior adhesive (Exposure 1 or Exterior), and grademarked indicating conformance with USDOC PS 1, USDOC PS 2, or applicable code evaluation reports.

2.3 Preservative Treatment

2.3.1 General

All exterior foundation wall framing and sheathing (except the upper top plate); all interior bearing wall framing and sheathing, posts or other wood supports used in crawl spaces; all sleepers, joists, blocking and plywood subflooring used in basement floors; and all other plates, framing and sheathing in contact with the ground or in direct contact with concrete shall be pressure treated with preservatives. Treatment shall be in accordance with AWPA U1: Commodity Specification A, Section 4.2 Lumber and Plywood for Permanent Wood Foundations; UC4B Retentions and AWPA T1, Processing and Treatment Standard; Section 8, Special Requirements for Permanent Wood Foundation Material.

Exceptions:

1. Members 8 in. or more above finish grade are not required to be preservative treated.
2. Untreated lumber may be used in interior load-bearing walls where such walls are supported directly on top of a treated floor system.

2.3.2 Marking

Each piece of treated wood shall bear the quality mark of an inspection agency listed by an accreditation body complying with the requirements of the American Lumber Standard Committee Treated Wood Program or equivalent.

2.3.3 Cutting or Drilling

Where preservative treated lumber is required in a PWF and is cut or drilled after treatment, the cut surface and drilled holes shall be field treated in accordance with AWPA M4.

2.4 Connections In Preservative-Treated Wood

2.4.1 General

Fasteners and connectors used in preservative-treated wood shall be of Type 304 or 316 stainless steel.

Exception:

When framing lumber is treated with Chromated Copper Arsenate (CCA) and the moisture content of the framing remains at 19 percent or less (such as studs, blocking, and top plates of exterior and

interior basement walls), hot-dipped galvanized (zinc-coated) steel fasteners conforming to the requirements of ASTM A153 shall be permitted in lumber-to-lumber connections.

2.4.2 Corrosion of Metal Parts

Stainless steel parts and galvanized steel parts shall not be placed in contact with one another.

2.5 Aggregate for Footings and Fill

2.5.1 Gravel

Gravel shall be washed, and free from organic, clayey, or silty soils. The maximum size stone shall not exceed $\frac{3}{4}$ inch and the gravel shall contain not more than 10 percent of fine material that passes a No. 4 (3/16 in. or 4.75 mm) sieve.

2.5.2 Sand

Sand shall be coarse, not smaller than 1/16 in. grains and shall be free from organic, clayey, or silty soils.

2.5.3 Crushed Stone

Crushed stone shall be washed and shall contain not more than 10% of fine material that passes through a No. 4 (3/16 in. or 4.75 mm) sieve. The maximum sized stone shall not exceed $\frac{3}{4}$ inch.

2.6 Caulking Compound

Caulking compound shall be capable of expanding and contracting to provide a moisture proof seal under the conditions of temperature and moisture content at which it will be applied and used.

2.7 Polyethylene Sheeting

Polyethylene sheeting shall be UV resistant, minimum 6 mil thick, and conform to the requirements of ASTM D 4397.

2.8 Polyethylene Sheeting Adhesive

2.8.1 Bonding to Sheathing

The adhesive used to attach polyethylene sheathing to wall sheathing shall be capable of bonding polyethylene sheathing to preservative treated wood sheathing under the conditions of temperature and moisture content at which the adhesive will be applied and used.

2.8.2 Sealing Joints in Polyethylene Sheeting

The adhesive used to bond sheets of polyethylene sheathing to each other shall be capable of sealing joints under the conditions of temperature and moisture content at which the adhesive will be applied and used.

SOIL: TYPES, STRUCTURAL PERFORMANCE, DRAINAGE

3.1	Soil Types	10
3.2	Soil Structure Characteristics	10

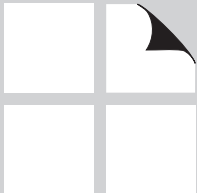

3.1 Soil Types

Soil types shall be as determined by the authority having jurisdiction (AHJ) unless a geotechnical investigation report is provided to and approved by the AHJ. Soil types classified under the Unified Soil Classification System shall be in accordance with ASTM D 2487.

3.2 Soil Structure Characteristics

3.2.1 Design Properties of Soils

Design properties shall be based on the minimum design properties required by the AHJ unless an approved geotechnical investigation report is provided.

3.2.2 Soils With Good to Medium Drainage

Soils classified as GW, GP, SW, SP, GM, SM, GC, SC, ML, and CL which are characterized by good to medium drainage characteristics, shall be permitted for use with PWF basements or crawl space applications provided the following requirements are satisfied:

1. the lot grading complies with 4.1.1;
2. the backfill is free of voids, organic matter, or chunks of clay;
3. polyethylene sheeting is applied under the basement floor and on exterior walls and complies with 4.1.3 and 4.1.6 respectively;
4. for basements, a sump is provided and complies with 4.1.4; and,
5. for basements, drainage underneath the foundation complies with 4.1.2.

3.2.3 Soils With Poor Drainage

Soils classified as CH and MH which are characterized by poor drainage characteristics, shall be considered unsuitable for use with PWF basements or crawl space applications.

3.2.3.1 Suitable CH and MH Soils: Where CH and MH soils are deemed suitable for a PWF, the same limitations as Section 3.2.2 shall apply provided granular fill placed underneath the basement floor slab is to a depth not less than 6 inches.

3.2.3.2 Backfill: Backfill of CH (inorganic clays of high plasticity) or other types of expansive soils shall not be compacted dry. Backfill with MH soil types (inorganic silts, micaceous or diatomaceous fine sandy or silty soils, elastic silts) shall be compacted to prevent surface water infiltration.

3.2.4 Soils With Poor to Unsatisfactory Drainage

Soils classified as OL, OH, and Pt are characterized by poor-to-unsatisfactory drainage characteristics and shall not be permitted for use with PWF basements or crawl space applications.

Exception:

A PWF shall be permitted in CH or MH soils where a geotechnical investigation report, prepared by a registered design professional, specifies mitigation of the poor drainage characteristics and is approved by the AHJ. The same limitations as Section 3.2.2 shall apply provided granular fill is placed underneath the basement floor slab to a depth not less than 6 inches.

ENVIRONMENTAL CONTROL

4.1	Design for Dryness	12
4.2	Design for Climate Control	13

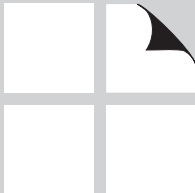

4.1 Design for Dryness

4.1.1 Drainage of Surface Water

Adjacent ground surfaces shall be sloped away from the structure at a slope of not less than one unit vertical in 20 units horizontal (5-percent slope) for a minimum distance of 10 feet measured perpendicular to the face of the wall, or an approved alternate method of diverting water away from the foundation shall be used. Provision shall also be made for drainage of accumulated surface water, including water from roofs and decks, away from the foundation to a natural drainage area or storm sewer.

4.1.2 Drainage Underneath Foundation

For basement construction in soils classified as GW, GP, SW, SP, GM, SM, GC, SC, ML, and CL a granular drainage layer of gravel, crushed stone, or sand shall be placed to a minimum thickness of 4 in. under the basement floor slab and all wall footings, including continuous concrete footings. For basement construction in soils classified as CH and MH, the granular drainage layer shall be placed to a minimum thickness of 6 in. under the basement floor slab and all wall footings. Provision shall be made for positive draining of this layer.

4.1.3 Polyethylene Sheeting under Concrete Slab, Wood Sleeper, and Raised Floor Systems

Minimum 6 mil thick polyethylene sheeting shall be applied over the granular drainage layer. Where a concrete slab is used, the concrete shall be poured over the sheeting. Where a wood sleeper floor system is used, sheeting shall be placed over wood sleepers supported by the granular drainage layer and under the basement floor joists. Joint laps shall not be sealed and a 2 in. gap between the sheeting shall be provided at ends of sleepers and wood footing plates to facilitate drainage of any water that inadvertently enters from above (i.e. plumbing leaks, etc.) into the granular drainage layer. Where a raised floor system is used, polyethylene sheeting shall be applied over the ground surface and shall be protected from damage by means of a protective cover.

4.1.4 Sump Requirements

Where there is habitable space below grade, a sump shall be provided to drain the granular drainage layer unless the foundation is installed in soils classified as GW, GP, SW, SP, GM, or SM. The sump shall extend 24 in. below the top of the granular drainage layer and shall be provided with positive gravity or mechanical drainage to remove any accumulated water. Drainage shall be by gravity to a sewer or to daylight, or a sump pump shall be provided.

Exception:

Where winter freeze-up is possible, drainage shall not be by gravity drain to daylight.

4.1.5 Plywood Joints in Foundation Walls

In basement construction, plywood joints in the foundation walls shall be sealed full length with approved caulking compound (see 2.6). All plywood joints shall be supported by 2 in. nominal or wider framing.

4.1.6 Polyethylene Sheeting on Exterior Walls

Minimum 6 mil thick polyethylene sheeting shall be applied over the below-grade portion of the exterior surface of exterior basement walls prior to backfilling. Joints in the sheeting shall be lapped 6 in. and sealed with adhesive (see 2.8.2). The top edge of the sheeting shall be bonded to the preservative treated wood sheathing to form a seal. Sheeting at ground surface shall be protected from mechanical damage and exposure by a grade board comprised of treated lumber, treated plywood, cement board, or brick attached to the wall 8 in. above finish ground surface and extending 4 in. below grade. The top edge of the sheeting shall be extended to the top edge of the grade board and shall be bonded to the sheathing to form a seal.

The joint between the grade board and the wall shall be caulked full length prior to fastening the grade board to the wall. The sheeting shall extend down to the bottom of the wood footing plate but shall not extend into the gravel footing.

4.1.7 Backfill

The space between the excavation and the foundation wall shall be backfilled with the same granular material used to support the footings, up to a minimum height of one foot above the top of the footing for soils with good to medium drainage (see 3.2.2), or half the total backfill height for soils with poor drainage (see 3.2.3).

Exception:

For soils with poor drainage that are deemed suitable for use with a PWF, drainage mats shall be permitted where deep frost penetration does not occur. Drainage mats shall be applied over polyethylene sheeting (see 4.1.6). For these cases, a 12 in. minimum backfill with gravel or other footing material, measured perpendicular to the vertical face of the wall along the full vertical extent of the drainage mat is required.

4.2 Design for Climate Control

4.2.1 Insulation of Exterior Walls

Wood foundations enclosing habitable space shall be insulated between studs or outside of the foundation wall in accordance with the requirements of the AHJ.

4.2.1.1 Minimum Gap: Where insulation is installed between studs in the below ground surface portion of the foundation wall, there shall be a minimum 2 in. gap between the bottom of the insulation and the bottom plate.

4.2.1.2 Crawl Space Insulation: In crawl space construction, insulation shall be permitted to be installed between floor joists or against the band joists and on the inner faces of the studs and plates of the crawl space foundation wall. Wall insulation in the crawl space foundation shall be separated from the soil by polyethylene sheeting. (see 4.1.3).

4.2.2 Vapor Barrier - with Vented Air Space

Where insulation is installed between studs, and a vented air space is provided between the insulation and plywood foundation wall, a vapor barrier shall be installed from the upper plate and extend down to the bottom plate. Refer to Figure 1.

Figure 1 PWF Exterior Basement Wall Showing Location of Vapor Barrier With Vented Air Space

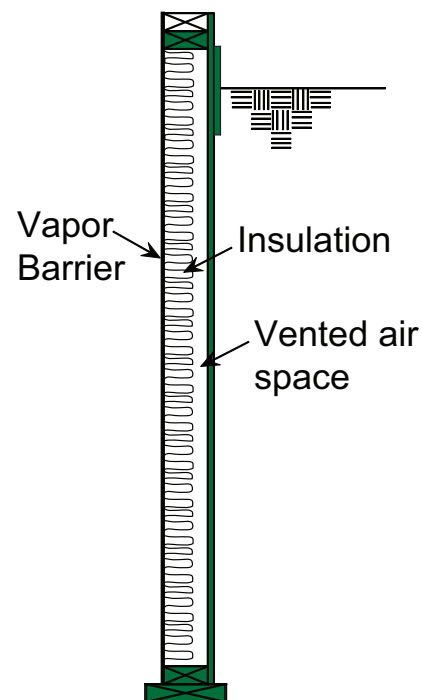

4.2.3 Vapor Barrier - with No Vented Air Space

Where insulation is installed between studs, and a vented air space is not provided between the insulation and the plywood foundation wall, a vapor barrier shall be installed from the upper plate down to approximately one foot below outside ground surface. This insulated portion of the stud cavity shall be closed off from the space below by folding an extension of the vapor barrier into the cavity and attaching it to the ply-

wood foundation wall. Additional insulation without vapor barrier shall be permitted to be installed below this level. Refer to Figure 2.

Figure 2 PWF Exterior Basement Wall Showing Location of Vapor Barrier with no Vented Air Space

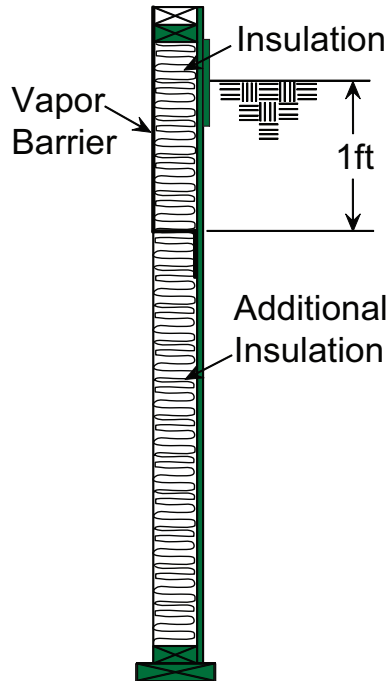

4.2.4 Ventilation of Crawl Space Foundation

Ventilation of a crawl space shall be provided in accordance with the requirements of the AHJ.

STRUCTURAL DESIGN

5.1	General	16
5.2	Material Design Standards	16
5.3	Design Loads and Design Methodology	16
5.4	PWF Wall Design	18
5.5	Footing Design	22
5.6	Basement Floor Design	24
5.7	Design of Framing Around Openings	24

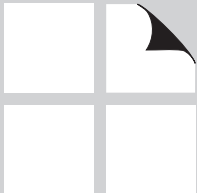

5.1 General

Each wood structural member and connection shall be of sufficient size and capacity to resist required design loads without exceeding the adjusted design value

5.2 Material Design Standards

Structural design of a PWF shall be in accordance with the *National Design Specification*[®] (*NDS*[®]) for *Wood Construction, Special Design Provisions for Wind and Seismic (SDPWS)* and provisions of these Specifications. Reference design values for sawn lumber, plywood, and connections are provided in the *NDS*. Nominal unit shear capacities for shear walls and diaphragms are provided in the *SDPWS* standard.

5.2.1 Framing

Framing members shall be designed in accordance with the *NDS*. Adjusted design values shall be based on wet-use service conditions (greater than 19 percent maximum moisture content).

Exception:

Adjusted design values for lumber shall be permitted to be based on dry-use service conditions where the moisture content of the framing remains at 19 percent or less (such as studs, blocking, and top plates of exterior and interior basement walls).

5.2.2 Sheathing

Sheathing shall be designed in accordance with the *NDS*. Adjusted design values and section properties

for plywood sheathing shall be based on wet-use service conditions (moisture content 16 percent or more).

5.2.3 Joints, Fastenings, and Connections

Joints, fastenings, and connections shall be designed in accordance with the *NDS*.

5.2.3.1 Nails: Adjusted design values for nails shall be determined in accordance with the *NDS*.

5.2.3.2 Connectors: Adjusted design values for connectors shall conform to the requirements of the AHJ and/or manufacturers' recommendations.

5.2.4 Soils

For structural design purposes, the type of soil shall be identified by the AHJ, obtained from an approved soil map, or determined by a qualified geotechnical engineer.

5.2.4.1 Soil Bearing Pressure: Allowable soil bearing pressures shall be in accordance with the building code under which the foundation is designed or determined by a qualified geotechnical engineer.

5.3 Design Loads and Design Methodology

Permanent wood foundations and their structural members and connections shall be designed to safely support all prescribed design loads.

5.3.1 Loads and Load Combinations

Minimum design loads, load combinations, and load factors shall be in accordance with the building code under which the foundation is designed, or where

applicable, other recognized minimum design load standards, such as *ASCE/SEI 7*.

5.3.2 Lateral Load Distribution

Minimum lateral soil loads shall be determined in accordance with the building code. One method of determining lateral soil pressure is described in Figures 3 and 4 and used in Sections 5.4 through 5.7. In the absence of more rigorous design procedures, this method shall be used for calculating induced bending

moments and shears for combinations of backfill depth and wall height.

Figure 3 Pressure Diagram Used to Calculate Bending Moment, Shear, and Deflection in Foundation Walls with Basement Resisting Lateral Soil Load.

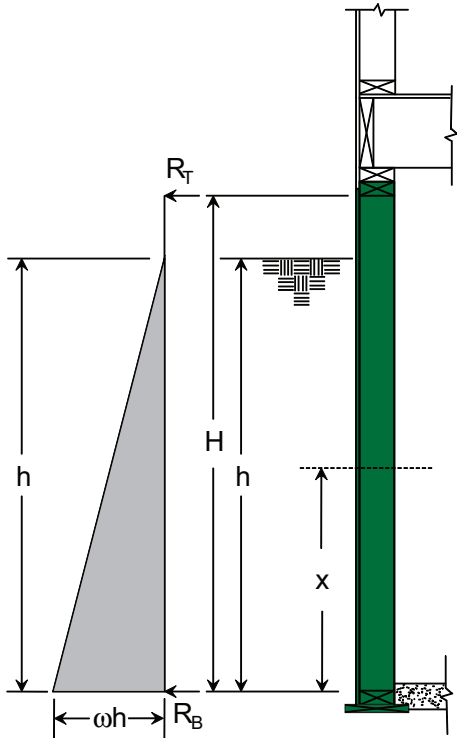
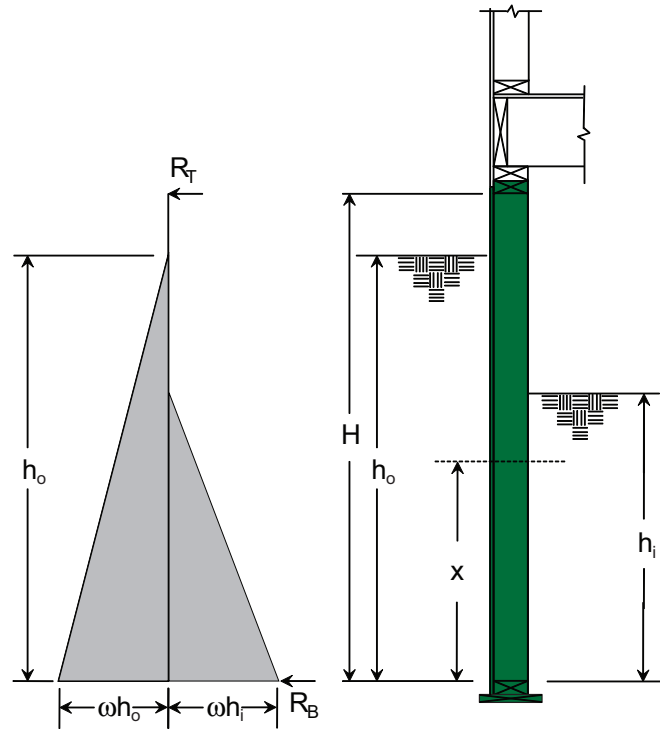

Figure 4 Pressure Diagram Used to Calculate Bending Moment, Shear, and Deflection in Foundation Walls with Crawl Space Resisting Lateral Soil Load.



5.3.3 Design Methodology

Design methods specified in Sections 5.4 through 5.7 are applicable for member and connection design where backfill is level and adjacent to the wall with no superimposed load adjacent to or near the wall.

5.4 PWF Wall Design

Wall framing and sheathing shall be sized and fastened to resist required design loads. Knee walls shall be designed to support brick veneer or surcharge loading (i.e. from an attached garage), where appropriate.

5.4.1 Design of Studs

5.4.1.1 Combined Bending and Axial Loading: Exterior wall studs shall be designed to resist the combined out-of-plane bending and axial stresses in accordance with the NDS.

5.4.1.2 Induced Bending Moment: Out-of-plane bending stresses in 5.4.1.1 shall be derived from the maximum induced bending moment which shall be calculated as follows:

(a) For basement walls:

$$M_{stud} = \frac{\omega h^3 s}{72H} \left[H - h + \frac{2h}{3} \sqrt{\frac{h}{3H}} \right] \quad (1)$$

$$\text{Point of Maximum Moment: } x = h \left[1 - \sqrt{\frac{h}{3H}} \right] \quad (2)$$

where:

M_{stud} = maximum design bending moment in PWF stud, ft-lbs

ω = design lateral soil load, lbs/ft² per foot of depth

h = backfill height (from top of bottom plate to ground surface), ft

H = height of PWF wall (from top of bottom plate to bottom of top plate), ft

x = location of maximum design bending moment in PWF stud (from top of bottom plate), ft

s = PWF stud spacing, in.

(b) For crawl space walls:

$$a = \frac{h_o^3 - h_i^3}{3H} \quad (3)$$

When $h_o - h_i \geq \sqrt{a}$

$$M_{stud} = \frac{\omega a s}{24} \left(H - h_o + \frac{2}{3} \sqrt{a} \right) \quad (4)$$

When $h_o - h_i < \sqrt{a}$

$$M_{stud} = \frac{\omega s (h_o^2 - h_i^2 - a)^2}{96(h_o - h_i)} \quad (5)$$

where:

h_o = backfill height on outside of PWF crawl space wall: distance from top of bottom plate to ground surface, ft

h_i = backfill height on inside of PWF crawl space wall: distance from top of bottom plate to ground surface, ft

5.4.1.3 Induced Shear Forces: The maximum induced shear force in the PWF stud shall be calculated as follows:

(a) For basement walls:

$$V_{stud} = \frac{\omega s}{72H} \left(h - \frac{d_{stud}}{12} \right)^2 \left(3H - h - \frac{d_{stud}}{6} \right) \quad (6)$$

where:

V_{stud} = design shear force in PWF stud, lbs

d_{stud} = depth of PWF stud perpendicular to wall, in.

(b) For crawl space walls:

$$V_{stud} = \frac{s}{12} \left[R_B - \frac{\omega d_{stud}}{12} (h_o - h_i) \left(1 - \frac{d_{stud}}{24H} \right) \right] \quad (7)$$

where:

R_B = reaction at bottom of PWF stud (top of bottom plate), lbs/ft (lineal foot of wall)
See 5.4.4.2, Equation 14.

5.4.1.4 Deflection: Basement wall studs shall be designed for out-of-plane deflection due to lateral soil pressures. The maximum out-of-plane long-term deflection from soil loads shall be limited to H/240 and calculated as follows:

$$\Delta_{stud} = \frac{\omega s h (H - x)}{2.5 E_{stud} I_{stud} H h} K_{\Delta_{stud}} \quad (8)$$

where:

$$K_{\Delta_{stud}} = 10h^3(2H - x)x - 3h^5 + \frac{3H}{(H - x)}(h - x)^5$$

Δ_{stud} = maximum out-of-plane long-term deflection in PWF wall stud, in.

ω = design lateral soil load, lbs/ft² per foot of depth

s = PWF stud spacing, in.

H = height of PWF wall (from top of bottom plate to bottom of top plate), ft

x = location of maximum design bending moment in PWF stud (from top of bottom plate), ft

h = backfill height (from ground surface to top of bottom plate, ft (see Figure 3))

E = modulus of elasticity of PWF stud, lbs/in.²

I = moment of inertia of PWF stud, in.⁴

5.4.2 Design of Exterior Wall Sheathing

5.4.2.1 Induced Bending: Plywood shall be designed to resist out-of-plane bending forces due to lateral soil loads. In no case shall plywood thickness be less than 3/8 inch thick.

5.4.2.1.1 The maximum induced out-of-plane bending moment for plywood at the base of the wall shall be calculated as follows:

(a) For basement walls:

$$M_{panel} = \frac{\omega s^2}{c} (h - 0.5) \quad (9)$$

where:

M_{panel} = maximum PWF plywood bending moment, in.-lbs/ft (lineal ft of plywood panel width)

ω = design lateral soil load, lbs/ft² per foot of depth

s = PWF stud spacing, in.

c = 120 for panels continuous across three or more spans (panels covering at least three stud openings) or 96 for panels continuous across two spans or one span

h = backfill height, ft (see Figure 3)

(b) For crawl space walls:

$$M_{panel} = \frac{\omega s^2}{c} (h_o - h_i) \quad (10)$$

5.4.3 Design of Top and Bottom Plates

5.4.3.1 Bearing: Top and bottom wall plates shall be designed to resist bearing forces from studs and posts.

5.4.3.2 Compression Perpendicular to Grain: The adjusted compression perpendicular to grain resistance, $F'_{c\perp}$, of the top plate and the bottom plate supporting PWF studs shall be greater than or equal to the induced stress due to gravity loads and forces from overturning resulting from wind or seismic and differential backfill (where applicable).

5.4.3.3 Joints: Joints in the upper top plate shall be staggered at least one stud space from joints in the lower top plate. Joints in the bottom plate shall be staggered at least one stud space from joints in the footer plate.

5.4.4 Design of Lateral Connections

5.4.4.1 Top of Wall: Connections at the top of the foundation wall shall be designed to transfer lateral forces from the top of the wall studs into the adjacent floor assembly. The maximum induced reaction at the top of the exterior wall shall be calculated as follows:

(a) For basement walls:

$$R_T = \frac{\omega h^3}{6H} \quad (11)$$

where:

R_T = reaction at top of PWF stud (bottom of top plate), lbs/ft (lineal foot of wall)

(b) For crawl space walls:

$$R_T = \frac{\omega a}{2} \quad (12)$$

where:

$$a = \frac{h_o^3 - h_i^3}{3H}$$

5.4.4.2 Bottom of Wall: Lateral loads at the bottom of a basement wall shall be transferred through bearing of the studs against the basement floor. The reaction force from bearing shall be used to evaluate compression perpendicular to grain in the wall stud. The maximum induced reaction at the bottom of the exterior wall shall be calculated as follows:

(a) For basement walls:

$$R_B = \omega \left(\frac{h^2}{2} - \frac{h^3}{6H} \right) \quad (13)$$

where:

R_B = reaction at bottom of PWF stud (top of bottom plate), lbs/ft (lineal foot of wall)

(b) For crawl space walls:

$$R_B = \frac{\omega}{2} \left(h_o^2 - h_i^2 - \frac{h_o^3 - h_i^3}{3H} \right) \quad (14)$$

5.4.5 Design for In-Plane Shear

The PWF system, including foundation walls, the first floor diaphragm, and connections, shall be designed to resist lateral loads from differential backfill heights and in combination with wind or seismic loads. Shear walls and diaphragms shall be designed in accordance with the *SDPWS* standard. When designing to resist lateral loads from differential backfill heights alone (not considering a load combination including wind or seismic), shear wall and diaphragm nominal design capacities shall be multiplied by 0.56 to adjust for permanent load duration.

5.4.5.1 Induced Lateral Load Due to Differential Backfill Height: The induced lateral load acting through the diaphragm due to differential backfill on opposite sides of the building shall be determined as follows:

$$B_s = \frac{\omega}{6H} (h_n^3 - h_f^3) \quad (15)$$

where:

h_n = height of backfill on the side of the building with greatest depth of backfill, ft

h_f = height of backfill on the side of the building opposite the side with greatest depth of backfill, ft

H = height of PWF wall (from top of bottom plate to bottom of top plate), ft

B_s = Induced lateral load in diaphragm due to differential backfill, lbs per foot of length of wall perpendicular to the direction of the applied force

ω = design lateral soil load, lbs/ft² per foot of depth

B_s is therefore the net resultant of the two opposing values of R_T . Calculation of shear in the diaphragm and shear walls will depend on the orientation of the framing.

5.4.5.2 Induced Lateral Load Due to Wind or Seismic: The induced lateral load due to wind or seismic loads acting on the full structure shall be determined in accordance with Section 5.3.1.

5.4.5.3 First Floor Diaphragm for Buildings of Differential Backfill: First floor diaphragms shall be designed to resist loads from wind or seismic and differential backfill (where applicable) in accordance with applicable loads and load combinations in Section 5.3.1 and design provisions in the *SDPWS* standard.

5.4.5.4 PWF Shear Walls: Shear walls shall be designed in accordance with applicable loads and load combinations in Section 5.3.1 and design provisions in the *SDPWS* standard. Shear walls shall be designed to transfer the shear load from the first floor diaphragm and upper stories to the footings.

5.4.5.5 Design for Uplift and Overturning: Design for uplift and overturning shall be in accordance with applicable loads and load combinations in 5.3.1 and design provisions of the *SDPWS* standard.

5.4.5.5.1 Anchorage: Anchorage shall be provided to resist that portion of the uplift and overturning that is not resisted by the dead load of the structure. Where anchorage is required, the following provisions shall be permitted:

(a) For basements:

Foundation wall studs shall be anchored to the basement floor slab by spikes (see Figure 5) and designed using the provisions of Chapter 11 of the *NDS*. The spikes are driven from the inside edge of the stud in such a location that they will be embedded in the concrete when the slab is poured. Adequacy of the anchorage of upper stories to the foundation wall shall also be determined. Connectors or additional fasteners shall be used where additional resistance is required.

Figure 5 Basement Wall Anchorage to Resist Wind Uplift

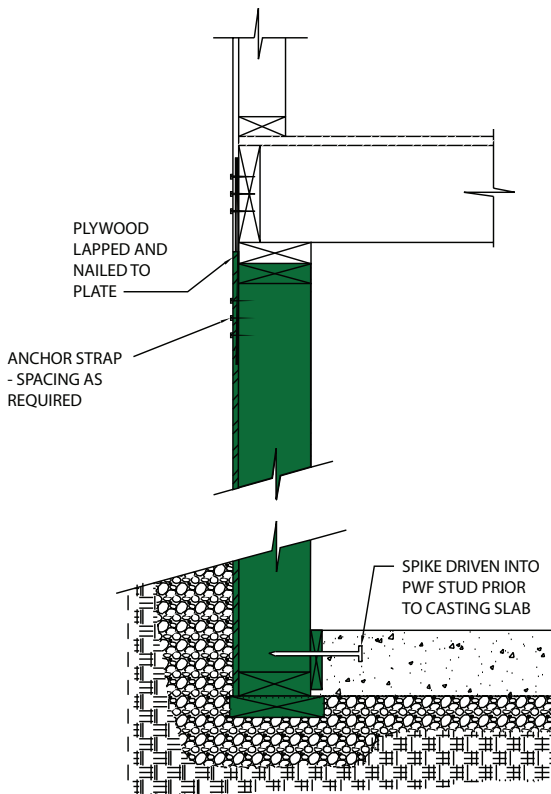

(b) For crawl spaces:

Foundation wall studs shall be anchored to a concrete pad on each side of the wall by spikes and designed using the provisions of Chapter 11 of the *NDS*. (see Figure 6). The concrete pad shall be cast on top of the gravel, coarse sand, or crushed stone footing.

Figure 6 Crawl Space Wall Anchorage to Resist Wind Uplift

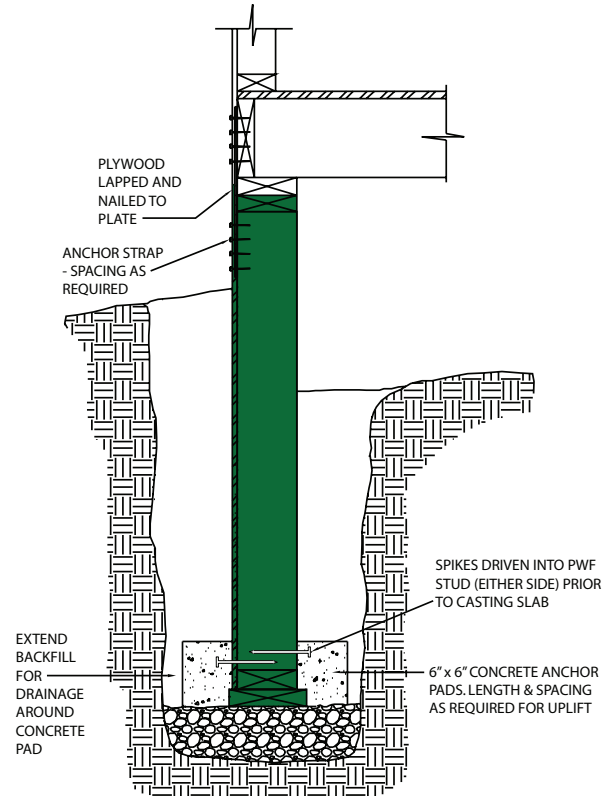

(c) For foundations supporting manufactured housing:

The design of anchorage for overturning and uplift shall comply with *NFPA 225*.

5.4.6 Design of Interior Load-Bearing Walls

Design of studs, plates, footings, and connections for interior load-bearing walls shall be in accordance with provisions in Sections 5.4.1, 5.4.3, 5.5, and 5.2.3 respectively.

5.5 Footing Design

5.5.1 General

Footings shall be of PWF treated wood and gravel (composite footing), concrete, or other durable materials.

5.5.1.1 Frost Line: The bottom of the wood footing plate shall not be located above the maximum depth of frost penetration unless the granular footing extends to the maximum depth of frost penetration and is either connected to positive mechanical or gravity drainage, at or below the frost line, or is installed in soils classified as GW, GP, SW, SP, GM, GC, SC, ML, and CL where the permanent water table is below the frost line.

5.5.1.2 Granular Footing Protection: Where a wood footing plate is less than 12 inches from the ground surface, the granular footing shall be protected against surface erosion or mechanical disturbance.

5.5.2 Composite Footings

Where a PWF incorporates a composite footing (consisting of a wood footing plate and a granular drainage layer), it shall be designed to distribute the axial design load from the framed wall to the granular drainage layer underneath which in turn shall be designed to distribute it to the supporting soil.

5.5.2.1 Width: Wood footing plate width for composite footings shall be determined by the bearing pressure of the gravel, coarse sand, or crushed stone footing.

(a) Wood Footing Plate Supporting a Wall: The minimum width of a wood footing plate bearing on a granular drainage layer shall be calculated as:

$$w_{fp} \geq \frac{12p}{q_{footing}} \quad (16)$$

where:

w_{fp} = width of wood footing plate, in

p = axial ASD design load, lbs/ft (lineal foot of wall)

$q_{footing}$ = allowable bearing pressure between wood footing plate and granular drainage layer, lbs/ft²

(b) Footing Plate Supporting Posts or Piers: The minimum area for a footing plate supporting posts or piers is:

$$A_{fp} = \frac{144P}{q_{footing}} \quad (17)$$

where:

A_{fp} = area of wood footing plate, in.²

P = axial ASD design load, lbs

5.5.2.2 Tension Perpendicular to Grain: When the wood footing plate is wider than the bottom wall plate, the adjusted ASD tension perpendicular to grain resistance, $F'_{t\perp}$, of the wood footing plate shall be greater than or equal to the induced ASD tension perpendicular to grain stress due to cross-grain bending using the following formula:

$$F'_{t\perp} \geq \frac{p(x_{fp})^2}{4(t_{fp})^2 w_{fp}} \quad (18)$$

where:

p = axial ASD design load on footing plate, lbs/ft (lineal foot of footing plate)

$F'_{t\perp}$ = adjusted ASD tension perpendicular to grain resistance which is assumed to be one-sixth of the adjusted ASD shear design value parallel to grain (horizontal shear), (F'_v), psi

t_{fp} = thickness of wood footing plate, in.

w_{fp} = width of wood footing plate, in.

x_{fp} = cantilever length of wood footing plate, in.

$$= \frac{w_{fp} - w_{bp}}{2}$$

w_{bp} = width of wall bottom plate, in.

Where the induced ASD tension perpendicular to grain stress exceeds one-sixth the adjusted ASD unit shear resistance for the wood footing plate, plywood panel strips or stepped wood framing members shall be permitted to reinforce the wood footing plate as follows.

(a) Plywood Reinforcing Strip: Where the plywood reinforcing strip is on the bottom, it shall be the same width as the lumber footing plate. Where the plywood strip is on the top, it shall be no more than 2 inches narrower than the lumber footing plate and shall be centered thereon.

(b) Multi-ply Plywood Footing Plate: Layers of plywood shall be permitted for use as multi-ply plywood footing plates. The adjusted ASD design bending strength of the multi-ply plywood footing plate, $F'_b S$, (per lineal foot of footing plate) shall be greater than or equal to the induced ASD bending moment in the plywood footing plate, M_{fp} .

$$M_{fp} = \frac{p(x_{fp})^2}{2w_{fp}} \quad (19)$$

where:

M_{fp} = induced ASD design bending moment in multi-ply plywood footing plate, in.-lbs/ft (lineal foot of plywood footing plate)

p = axial ASD design load on footing plate, lbs/ft

w_{fp} = width of multi-ply plywood footing plate, in.

x_{fp} = cantilever length of multi-ply plywood footing plate, in.

$$= \frac{w_{fp} - w_{bp}}{2}$$

w_{bp} = width of wall bottom plate, in.

5.5.3 Bearing Stress on Soil

5.5.3.1 General: Depth and width of a granular footing shall be determined by considering the bearing pressure between the gravel, coarse sand, or crushed stone and the supporting soil. The gravel, coarse sand, or crushed stone footing shall have a width not less than twice the wood footing plate width, $w_{footing} \geq 2w_{fp}$, and a depth not less than $\frac{3}{4}$ of the wood footing plate

width, $d_{footing} \geq 3/4w_{fp}$. For basement floors, the granular footing depth shall not be less than the required depth of the granular fill under the floor. The footing shall be confined laterally by backfill, granular fill, undisturbed soil, or by other equivalent means.

5.5.3.2 Soil Bearing Stress: The induced bearing stress on the soil (q_{soil}) shall be calculated as follows:

(a) Footing Supporting a Wall:

$$q_{soil} = \frac{12p}{w_{fp} + 2d_{footing} \tan 30^\circ} \quad (20)$$

where:

p = axial ASD design load, lbs/ft

w_{fp} = width of wood footing plate, in.

$d_{footing}$ = depth of granular footing, in.

q_{soil} = induced bearing pressure on soil, lbs/ft²

For the minimum footing depth, $d = 0.75w_{fp}$, $q_{soil} = 6.43 p/w_{fp}$

(b) Footing Supporting Posts and Piers:

$$q_{soil} = \frac{144p}{(w_{fp} + 2d_{footing} \tan 30^\circ)(\ell_{fp} + 2d_{footing} \tan 30^\circ)} \quad (21)$$

where:

q_{soil} = induced bearing pressure on soil from footing, lbs/ft²

w_{fp} = width of wood footing plate, in.

ℓ_{fp} = length of wood footing plate, in.

$d_{footing}$ = depth of granular footing, in.

P = axial ASD design load, lb

5.5.3.3 Footing Plate Stiffness: The footing plate shall provide adequate stiffness to distribute the load uniformly, or shall be reinforced.

5.6 Basement Floor Design

5.6.1 Concrete Slab Floors

Basement floors comprised of a concrete slab shall be designed in accordance with accepted practices (e.g., *ACI 318*), but shall not be less than 3.5 inches in thickness.

5.6.2 PWF Basement Floors

Basement floors comprised of wood framing shall be designed to withstand axial forces from lateral soil pressures at the base of the exterior foundation walls and bending moments resulting from basement floor live and dead loads. Basement floors shall be designed to meet joist deflection requirements between joist supports.

5.6.2.1 Unbalanced Lateral Soil Loads: Unless special provision is made to resist sliding caused by unbalanced lateral soil loads, wood basement floors shall be limited to applications where the differential depth of fill on opposing exterior foundation walls is 2 feet or less.

5.6.2.2 Lateral Soil Load Transfer: Joists in wood basement floors shall laterally bear tightly against the narrow face of studs in the PWF side wall or be toe-

nailed into a bandjoist which is nailed to the wall studs comprising the PWF side wall. When PWF stud and joist spacing differ, the band joist shall be designed to transfer lateral soil loads from the studs in the PWF side wall to the basement floor joists.

For PWF end walls, blocking shall be provided between joists to transfer lateral forces at the base of a PWF end wall into the floor system. The plywood sub-floor shall be continuous over lapped joists or over butt joints between in-line joists. The end wall bandjoist shall be designed for the out-of-plane bending from the lateral soil loads.

5.6.2.3 Restraint Against Floor Buckling: Where required, restraint against buckling of the floor shall be provided by interior bearing walls or by stub walls designed to be anchored in the supporting soil below.

5.6.2.4 Concentrated Loads: Footings under posts or load-bearing partitions bearing on wood basement floors shall be designed to provide uniform load distribution to the gravel, coarse sand, or crushed stone. Wood sleepers supporting wood basement floor joists shall be designed as footing plates for distributing floor loads to the gravel, coarse sand, or crushed stone.

5.7 Design of Framing Around Openings

5.7.1 Openings in Foundation Walls and 1st Floor Diaphragms

Openings in foundation walls and the first floor diaphragm interrupt the regular spacing of framing members. Members forming the perimeter of such openings shall be designed to resist the additional loads which are imposed as a result of the loss of such framing due to the opening. Joints between framing members around openings shall be designed to transfer the imposed loads, by direct bearing, fasteners, framing anchors, or by other means.

5.7.1.1 Headers and Support Studs: Headers and support studs (jack studs and full-height studs) at door openings, and headers at window openings, are not normally subjected to soil loads and are framed as

above-ground wood frame construction. For window openings in foundation walls exceeding 36 inches in length, headers and support studs shall be designed for tributary roof and floor loads.

5.7.1.2 Window Openings: At window openings, cripple studs and sills in foundation walls shall be checked for bending from lateral soil pressure on the studs below the sill. Header support studs shall be designed for the combined effects of bending from lateral soil pressure on the attached sill and axial loads resulting from the structure above (see 5.4.1).

5.7.1.3 Stairway Openings: Header and trimmer joists at stairways shall be designed for the side thrust from the top of the wall, as well as the vertical load from the floor.

REFERENCES

R

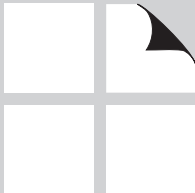

REFERENCES

1. ACI 318-02 Building Code Requirements for Structural Concrete, American Concrete Institute, Farmington Hills, MI, 2002.
2. ASCE/SEI 7-05, Minimum Design Loads for Buildings and Other Structures, American Society of Civil Engineers, Reston, VA, 2005.
3. ANSI/AF&PA NDS-2005 National Design Specification (NDS) for Wood Construction, American Forest & Paper Association (AF&PA), Washington, DC, 2005.
4. ANSI/AF&PA SDPWS-2005 Special Design Provisions for Wind and Seismic (SDPWS) Supplement, American Forest & Paper Association (AF&PA), Washington, DC, 2005.
5. ASTM A 153-03, Specification for Zinc Coating (Hot-Dip) on Iron and Steel Hardware, ASTM, West Conshohocken, PA, 2003.
6. ASTM D 2487-00, Practice for Classification of Soils for Engineering Purposes (Unified Soil Classification System), ASTM, West Conshohocken, PA, 2000.
7. ASTM D 4397-02, Standard Specification for Polyethylene Sheeting for Construction, Industrial, and Agricultural Applications, ASTM, West Conshohocken, PA, 2002.
8. AWWA, M4-01, Standard for the Care of Preservative-Treated Wood Products, American Wood Protection Association, Birmingham, AL, 2001.
9. AWWA, U1-06, Use Category System: User Specification for Treated Wood (Use Category 4B: Permanent Wood Foundations), American Wood Protection Association, Birmingham, AL, 2006.
10. American Softwood Lumber Standard, Voluntary Product Standard PS 20-05, National Institute of Standards and Technology, U.S. Department of Commerce, Gaithersburg, MD, 2005.
11. NFPA 225-05, Model Manufactured Home Installation Standard, National Fire Protection Association (NFPA), Quincy, MA, 2005.
12. PS1-95, Construction and Industrial Plywood, United States Department of Commerce, National Institute of Standards and Technology, Gaithersburg, MD, 1995.
13. PS2-04, Performance Standard for Wood-Based Structural-Use Panels, United States Department of Commerce, National Institute of Standards and Technology, Gaithersburg, MD, 2004.

PWF COMMENTARY

C1	General Requirements	29
C2	Materials	30
C3	Soil: Types, Structural Performance, Drainage	31
C4	Environmental Control	32
C5	Structural Design	33
	References	45

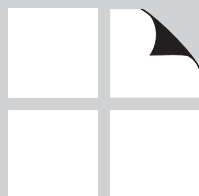
C

FOREWORD

The Commentary to the *Permanent Wood Foundation (PWF) Design Specification, ANSI/AF&PA 2007* is provided herein and includes background information for each section as well as derivations for structural design equations found in Chapter 5.

The Commentary follows the same subject matter organization as the *PWF*. Discussion of a particular provision in the *PWF* is identified in this Commentary by the same section or subsection. When available, references to more detailed information on specific subjects are included.

In developing the provisions of the *PWF*, much of the existing information contained in *Technical Report 7 - Basic Requirements for Permanent Wood Foundation System (5)* as well as the *Permanent Wood Foundation*

System Design, Fabrication, Installation (DFI) Manual (8) was used and updated and then carefully evaluated by the AF&PA Wood Design Standards Committee for the purpose of providing a standard of practice. It is intended that this document be used in conjunction with competent engineering design, accurate fabrication, and adequate supervision of construction. Therefore AF&PA does not assume any responsibility for errors or omissions in the *PWF* and *PWF Commentary*, nor for engineering designs and plans prepared from it.

Inquiries, comments, and suggestions from the readers of this document are invited.

American Forest & Paper Association

C1 GENERAL REQUIREMENTS

C1.1 Scope

This Specification defines a national standard of practice for structural design and construction of the permanent wood foundation (PWF) system.

Data and engineering judgements on which the Specification are founded are based on principles of engineering mechanics and satisfactory performance in service. However, they are not intended to preclude the use of other products or design procedures where it can be demonstrated that these products or design procedures provide for satisfactory performance in the intended application. Other criteria for demonstrating satisfactory performance may be proprietary or specialized design standards applicable to a particular component type. The appropriateness and acceptability of alternate criteria are determined by the designer and the code authority having jurisdiction.

C1.2 Conformance with Standards

The provisions of this Specification assume conformance with the standards specified.

C1.4 Notation

ω = design lateral soil load, lbs/ft² per foot of depth

Previously, the *Permanent Wood Foundation System Design Fabrication Installation (DFI) Manual* (8) used the term “w” and defined this term as being the “equivalent-fluid weight of soil, pounds per cubic foot.” The revised wording in the *PWF* is consistent with design lateral soil load provisions in *ASCE 7 – Minimum Design Loads for Buildings and Other Structures* (1).



C2 MATERIALS

C2.2 Sheathing

Unlike exterior sheathing attached to the exterior of PWF walls, non-structural finish materials attached to the interior of PWF walls need not be rated for exterior applications.

C2.3 Preservative Treatment

References to AWPA standards with respect to treatment are more clearly specified in the *PWF* and are consistent with similar provisions in section 2303.1.8.1 of the *International Building Code (IBC)* (7). Requirements for a “Permanent Wood Foundation Grade” quality mark are updated requiring the mark of an ALSC-accredited (or equivalent) inspection agency mark for treatment quality to be consistent with similar requirements for framing lumber in *PWF* 2.1.

Non-structural finish materials used in a PWF are not required to be preservatively treated. Note that basement floor underlayment is not considered to be part of the PWF system.

C2.5 Aggregate for Footings and Fill

C2.5.1 Gravel

The *PWF* specification is more specific in terms of quantifying grading requirements for both gravel and crushed stone - previously *Technical Report 7 - Basic Requirements for Permanent Wood Foundation System* (5) and the *DFI Manual* (8) required the material to be “well-graded” but did not provide any additional guidance.

C2.5.3 Crushed Stone

While current limits on maximum size for gravel and sand are carried forward from those in *Technical Report 7*, the maximum size for crushed stone has been increased from ½" to ¾". The *IBC* provides no limitation on maximum aggregate size for foundation drainage aggregate (*IBC* 1807.4.2 Foundation drain). It was noted that ¾" washed aggregate is common and easily obtained. Half-inch size aggregate is less common and more difficult to obtain. In addition, PWF drainage aggregate in the Canadian standard, *Construction of Preserved Wood Foundations* (9), is limited to a maximum size of 1½" for crushed stone or gravel.

C3 SOIL: TYPES, STRUCTURAL PERFORMANCE, DRAINAGE

C3.2 Soil Structural Characteristics

C3.2.3 Soils with Poor Drainage

See C3.2.4.

C3.2.4 Soils with Poor to Unsatisfactory Drainage

Provisions for soils with poor drainage and soils with poor to unsatisfactory drainage have been revised from *Technical Report 7 (5)* to indicate that mitigation techniques to alleviate poor drainage characteristics must be specified by a registered design professional and be approved by the authority having jurisdiction (AHJ) prior to the use of a PWF in such soils.



C4 ENVIRONMENTAL CONTROL

C4.1 Design for Dryness

C4.1.2 Drainage Underneath Foundation

A 6" granular drainage layer is required for soils with poor drainage (CH and MH) – as opposed to 4" for soils with good-to-medium drainage, to facilitate drainage and prevent build up of hydrostatic pressure.

Original provisions for drainage of footings in the *DFI Manual* (8) included a provision for pipe drains embedded in the concrete every 6 feet around the foundation. This provision, which was unique to continuous concrete footings, was removed based on feedback regarding the difficulty of constructing such drains in practice. *Technical Report 7* (5) does not make a distinction in terms of depth of granular drainage layer for soil types and uses a minimum of 4" for both composite footings and concrete footings.

C4.1.3 Polyethylene Sheeting Under Concrete Slab, Wood Sleeper, and Raised Floor Systems

Polyethylene sheeting requirements under raised floor systems and requirements for leaving a gap in the sheeting at the ends of each sleeper bay were added to provide better drainage to the granular drainage layer in the event of a plumbing leak.

C4.2 Design for Climate Control

C4.2.1.2 Crawl Space: For exterior walls in crawl space construction, installing insulation against the band joists and on the inner face of the stud wall (see Figure C4.2.1.2) is more energy efficient than installing insulation between floor joists.

Figure C4.2.1.2 Insulation of Exterior Walls in Crawl Space Construction

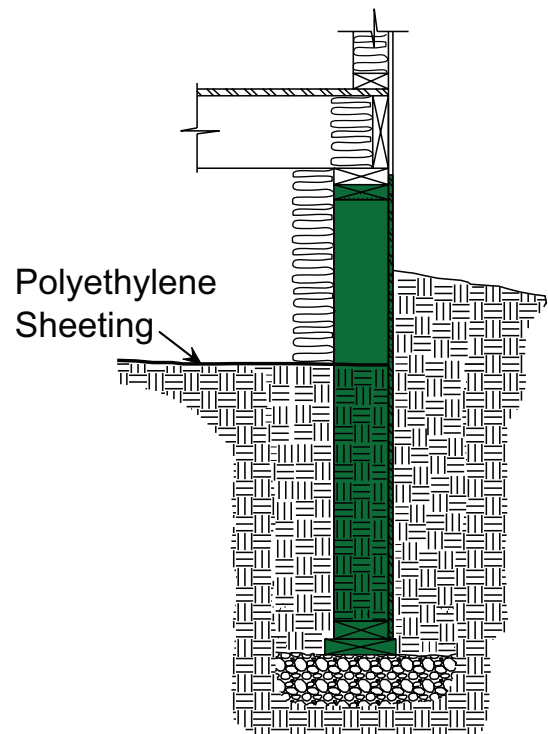

C5 STRUCTURAL DESIGN

C5.2 Material Design Standards

C5.2.3 Joints, Fastenings, and Connections

C5.2.3.1 Nails: Adjusted design values in the *National Design Specification (NDS) for Wood Construction* (3) are for common, box, or sinker nails per *ASTM F1667 Standard Specification for Driven Fasteners: Nails, Spikes, and Staples* (2) and are applicable to hot-dipped galvanized (zinc coated) common, box, or sinker nails, respectively.

Where the bending yield strength for Type 304 and Type 316 stainless steel nails is comparable to that for steel nails, adjusted design values in the *NDS* for common, box, or sinker nails can be used for stainless steel nails.

C5.3 Design Loads and Design Methodology

Figure C5.3 illustrates the typical loads and reactions in a permanent wood foundation.

Figure C5.3 Typical Loads and Reactions in a Permanent Wood Foundation

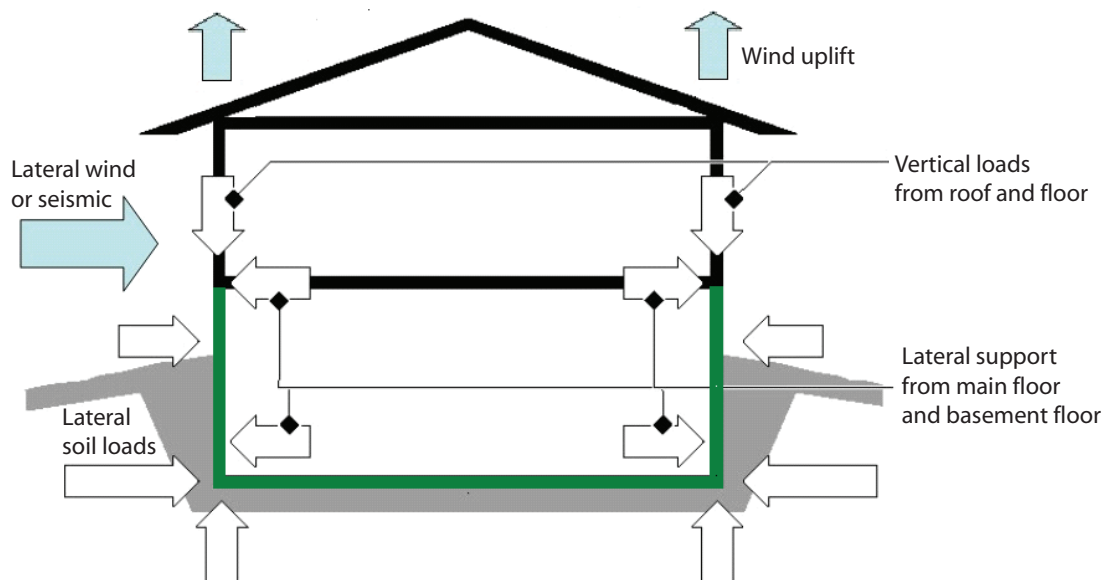

C5.3.2 Lateral Load Distribution

The formulas for calculating induced bending moment, induced shear, and deflection of the wall due to lateral soil loads assume essentially level ground immediately adjacent to the wall, with no superimposed load adjacent to the wall.

C5.4 PWF Wall Design

Equations for calculation of reactions at the top and bottom of the wall stud, maximum shear in the wall stud, and maximum bending moment in the stud are based on principals of statics, and are derived as follows:

Basement Application

Derivation of the reaction at top, R_T , and bottom, R_B , of a PWF stud (see Figure C5.4-1)

Figure C5.4-1 Lateral Soil Load Distribution and Reactions for PWF Basement Wall Stud

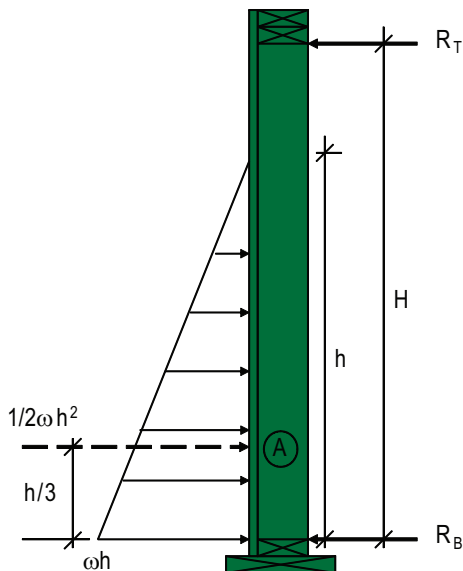

From statics, the sum of horizontal forces must equal zero:

$$R_T + R_B + \frac{1}{2}\omega h^2 = 0 \quad (\text{C5.4-1})$$

From statics, the sum of moments about any point must equal zero – therefore, summing moments about the point “A” or location of equivalent concentrated load from triangular soil load distribution:

$$R_T \left(H - \frac{h}{3} \right) - R_B \left(\frac{h}{3} \right) = 0 \quad (\text{C5.4-2})$$

Therefore,

$$R_B = R_T \left(\frac{H - \frac{h}{3}}{\frac{h}{3}} \right) = R_T \left(\frac{3H}{h} - 1 \right) \quad (\text{C5.4-3})$$

Substituting equation C5.4-3 into C5.4-1 and solving for R_T gives:

$$R_T = \frac{\omega h^3}{6H} \quad (\text{C5.4-4})$$

[Equation 11 as shown in PWF]

Substituting equation C5.4-4 into C5.4-3 and solving for R_B gives:

$$R_B = \omega \left(\frac{h^2}{2} - \frac{h^3}{6H} \right) \quad (\text{C5.4-5})$$

[Equation 13 as shown in PWF]

Derivation of maximum induced shear force, V_{stud} , in a PWF stud (see Figure C5.4-2).

Figure C5.4-2 Lateral Soil Load Distribution and Reactions for PWF Basement Wall Stud in Calculating Shear Forces

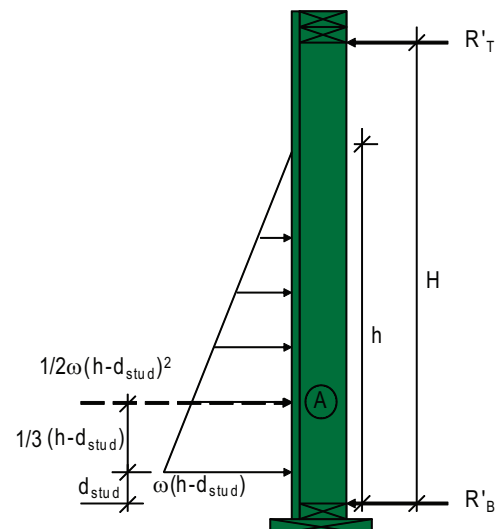

Note: In calculating maximum induced shear force, provisions of *NDS* 3.4.3.1 were followed which permits ignoring uniformly distributed loads within a distance from supports equal to bending member depth, in this case, the depth of the PWF stud.

Maximum induced shear force in the PWF stud will therefore equal the reaction at the bottom of the PWF stud as follows:

From statics, the sum of horizontal forces must equal zero:

$$R'_T + R'_B + \frac{1}{2} \omega \left(h - \frac{d_{stud}}{12} \right)^2 = 0 \quad (C5.4-6)$$

From statics, the sum of moments about any point must also be equal to zero – therefore, summing moments about point “A” or location of equivalent concentrated load from triangular soil load distribution:

$$R'_T \left(H - \frac{d_{stud}}{12} \right) - R'_B \left(\frac{d_{stud}}{12} \right) \quad (C5.4-7)$$

$$- \frac{1}{6} \omega \left(h - \frac{d_{stud}}{12} \right)^3 = 0$$

Therefore,

$$R'_T = \frac{\frac{1}{6} \omega \left(h - \frac{d_{stud}}{12} \right)^3 + R'_B \left(\frac{d_{stud}}{12} \right)}{\left(H - \frac{d_{stud}}{12} \right)} \quad (C5.4-8)$$

Substituting equation C5.4-8 into C5.4-7 and solving for R'_B gives:

$$R'_B = \frac{\omega \left(h - \frac{d_{stud}}{12} \right)^2 \left(H - \frac{d_{stud}}{12} \right)}{2H} \quad (C5.4-9)$$

$$- \frac{\omega \left(h - \frac{d_{stud}}{12} \right)^3}{6H}$$

$$V_{stud} = R'_B \left(\frac{s}{12} \right) \quad (C5.4-10)$$

Note: Since R'_B is expressed in lbs/ft and V_{stud} is expressed in in.-lbs, it is necessary to multiply R'_B by stud spacing, s .

Substituting equation C5.4-9 into C5.4-10, and simplifying gives the following:

$$V_{stud} = \frac{\omega s}{72H} \left(h - \frac{d_{stud}}{12} \right)^2 \left(3H - h - \frac{d_{stud}}{6} \right) \quad (C5.4-11)$$

[Equation 6 as shown in PWF]

Location of maximum bending moment can now be calculated by equating the general equation for shear to zero and solving for “ x ” (see Figure C5.4-3). Note that in this case, loads within a distance equal to the depth of the stud are not ignored.

From statics, the sum of horizontal forces must equal zero:

Figure C5.4-3 Calculating Shear at a Section “ x ” in the PWF Stud

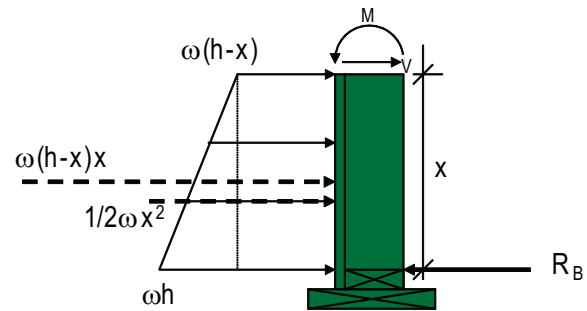

$$-V + R_B - \frac{1}{2} (\omega x)(x) - \omega (h-x)(x) = 0 \quad (C5.4-12)$$

Substituting equation C5.4-5 into C5.4-12, setting V equal to zero, and solving for “ x ” gives the following:

$$\left(\frac{1}{2} \omega \right) x^2 - (\omega h)x + \omega \left(\frac{h^2}{2} - \frac{h^3}{6H} \right) = 0 \quad (C5.4-13)$$

Solving for “ x ” using standard quadratic equations gives:

$$x = h \left(1 - \sqrt{\frac{h}{3H}} \right) \quad (C5.4-14)$$

[Equation 2 as shown in PWF]



From statics, summing bending moments at a given section and solving for M_{stud} gives (see Figure C5.4-4):

Figure C5.4-4 Calculating Bending Moment at a Section “x” in the PWF Stud

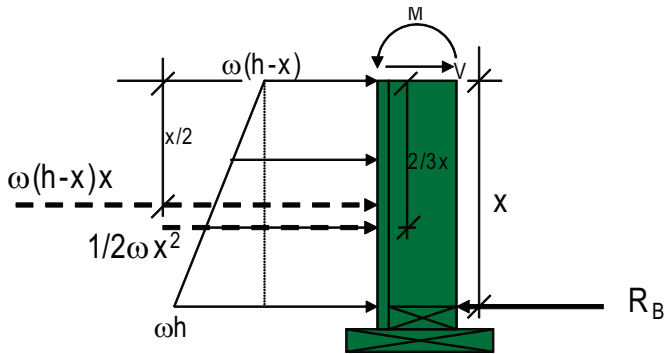

$$M_{stud} = \frac{\omega x^3}{6} - \frac{\omega x^2 h}{2} + \omega \left(\frac{h^2}{2} - \frac{h^3}{6H} \right) x \quad (C5.4-15)$$

Substituting equation C5.4-14 into C5.4-15, multiplying by “s/12” and simplifying to obtain a bending moment in ft-lbs gives the following:

$$M_{stud} = \frac{\omega h^3 s}{72H} \left[H - h + \frac{2h}{3} \sqrt{\frac{h}{3H}} \right] \quad (C5.4-16)$$

[Equation 1 as shown in PWF]

Deflection of Basement Wall Studs

The equation for calculation of maximum out-of-plane deflection due to lateral soil pressures assumes that contribution of added deflection due to P-delta effects is insignificant. The deflection limit, $H/240$, is derived based on the following prescriptive limit from the *DFI Manual* (8): “When the height of backfill is 6 feet or greater in a basement foundation, 2x4 studs on any spacing or 2x6 studs at spacings greater than 16 inches shall not be used unless framing is designed to prevent excessive wall deflection.”

Therefore, using Equation 8 from the *PWF* and the following parameters to calculate out-of-plane deflection, a deflection limit of $H/240$ was established:

$$\omega = 30 \text{ lbs/ft}^2 \text{ per ft of depth}$$

$$s = 24 \text{ in.}$$

$$H = 8 \text{ ft}$$

$$x = 3 \text{ ft (location of max. moment)}$$

$$h = 6 \text{ ft}$$

$$E = 1,400,000 \text{ psi (Southern Pine, 2x6, No. 3 and Stud)}$$

$$I = \frac{bd^3}{12} = \frac{1.5(5.5)^3}{12} = 20.8 \text{ in}^3$$

$$K_{\Delta stud} = 10h^3(2H-x)x - 3h^5 \quad (C5.4-17)$$

$$\begin{aligned} &+ \frac{3H}{(H-x)}(h-x)^5 \\ &= 10(6)^3[2(8)-3](3) - 3(6)^5 \\ &+ \frac{3(8)}{(8-3)}(6-3)^5 \\ &= 62,078 \end{aligned}$$

$$\Delta_{stud} = \frac{\omega sh(H-x)}{2.5E_{stud}I_{stud}Hh} K_{\Delta stud} \quad (C5.4-18)$$

$$\Delta_{stud} = \frac{30(24)6(8-3)}{2.5(140000)(20.8)(8)(6)} (62,078)$$

$$\Delta_{stud} = 0.384 \text{ in.}$$

$$\frac{H}{240} = \frac{8(12)}{240} = 0.40 \text{ in.} \quad (C5.4-19)$$

Crawl Space Application

Derivation of the reaction at top, R_T , and bottom, R_B , of a PWF stud (see Figure C5.4-5).

Figure C5.4-5 Lateral Soil Load Distribution and Reactions for PWF Crawl Space Wall Stud

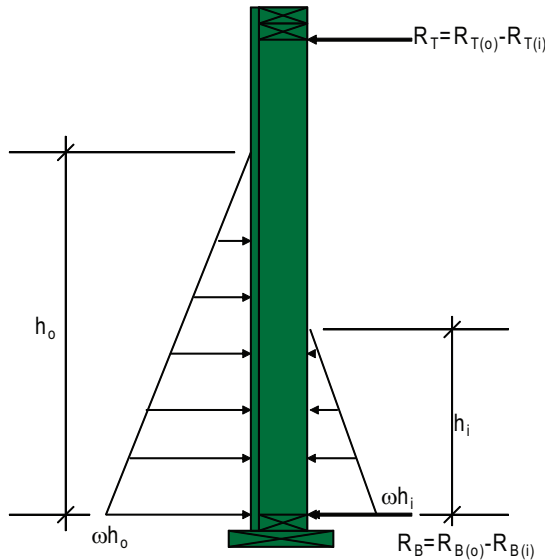

For crawl space applications, net reaction at the top and bottom of the stud is calculated by treating backfill within the crawlspace as a negative force as follows:

Reaction at bottom of wall stud due to backfill on outside of wall:

$$R_{B(o)} = \omega \left(\frac{h_o^2}{2} - \frac{h_o^3}{6H} \right) \tag{C5.4-20}$$

Reaction at bottom of wall stud due to backfill on inside of wall:

$$R_{B(i)} = \omega \left(\frac{h_i^2}{2} - \frac{h_i^3}{6H} \right) \tag{C5.4-21}$$

Therefore, the net reaction at the bottom of the wall stud is calculated as follows:

$$R_B = R_{B(o)} - R_{B(i)} \tag{C5.4-22}$$

Substituting equations C5.4-20 and C5.4-21 into equation C5.4-22 and simplifying gives the following:

$$R_B = \frac{\omega}{2} \left(h_o^2 - h_i^2 - \frac{h_o^3 - h_i^3}{3H} \right) \tag{C5.4-23}$$

[Equation 14 as shown in PWF]

Similarly, for the reaction at the top of the wall stud:

$$R_T = R_{T(o)} - R_{T(i)} \tag{C5.4-24}$$

Therefore,

$$R_T = \frac{\omega h_o^3}{6H} - \frac{\omega h_i^3}{6H} = \frac{\omega}{6H} (h_o^3 - h_i^3) \tag{C5.4-25}$$

Substituting the term “a” as derived later in equation C5.4-34 into C5.4-25 gives the following:

$$R_T = \frac{\omega a}{2} \tag{C5.4-26}$$

[Equation 12 as shown in PWF]

In calculating maximum induced shear force, provisions of NDS 3.4.3.1 are used which permit ignoring uniformly distributed loads within a distance from supports equal to bending member depth, in this case, the PWF stud.

Maximum induced shear force in the PWF stud will therefore be equal to the net reaction at the bottom of the PWF stud as follows:

Reaction at the bottom of the stud due to backfill on the outside of the wall, ignoring lateral loads within distance equal to d_{stud} :

$$R'_{B(o)} = \frac{\omega \left(h_o - \frac{d_{stud}}{12} \right)^2 \left(H - \frac{d_{stud}}{12} \right)}{2H} - \frac{\omega \left(h_o - \frac{d_{stud}}{12} \right)^3}{6H} \tag{C5.4-27}$$

Similarly, reaction at the bottom of the stud due to backfill on the inside of the crawlspace, ignoring loads within distance equal to d_{stud} :

$$R'_{B(i)} = \frac{\omega \left(h_i - \frac{d_{stud}}{12} \right)^2 \left(H - \frac{d_{stud}}{12} \right)}{2H} - \frac{\omega \left(h_i - \frac{d_{stud}}{12} \right)^3}{6H} \tag{C5.4-28}$$

Therefore, the net reaction at the bottom of the wall stud, based on ignoring lateral soil loads within a distance equal to d_{stud} , is calculated as follows:

$$R'_B = R'_{B(o)} - R'_{B(i)} \tag{C5.4-29}$$



Substituting equations C5.4-27 and C5.4-28 for $R'_{B(o)}$ and $R'_{B(i)}$ respectively, into C5.4-29 for R'_B and simplifying, gives the following:

$$V_{stud} = \frac{s}{12} \left[R_B - \frac{\omega d_{stud}}{12} (h_o - h_i) \left(1 - \frac{d_{stud}}{24H} \right) \right] \quad (C5.4-30)$$

[Equation 7 as shown in PWF]

Location of the maximum bending moment is where shear is equal to zero. Figure C5.4-6 shows the net load acting on the PWF stud. Net pressure on the wall stud is zero at the top of the outside soil and increases by the amount of outside wall pressure until the level of inside backfill is reached. From that point down to the footing plate, there is a uniform load pressure, equal to $\omega(h_o-h_i)$.

Depending on various factors, including the relative magnitude of h_o and h_i , the maximum bending moment will either be located in the region along the PWF stud which is below the inside backfill (net lateral uniform distributed load) or in that region which is above the inside backfill (net triangular lateral load distribution).

Figure C5.4-6 Net Lateral Soil Load Distribution and Reactions for PWF Crawl Space Wall Stud

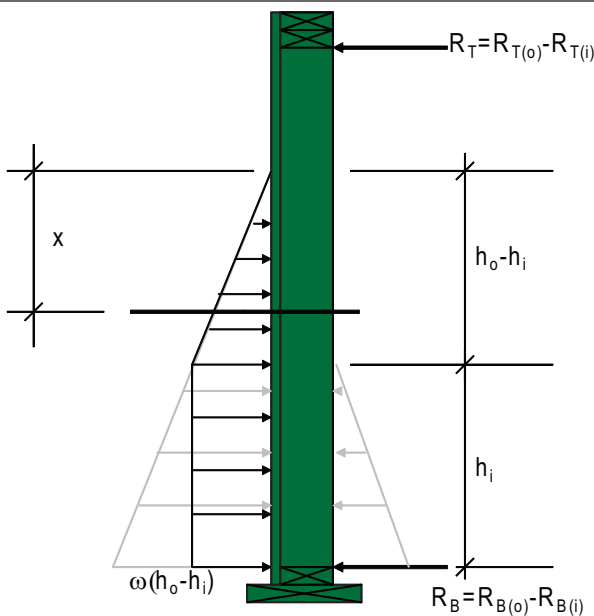

From statics, the sum of horizontal forces must equal zero (see Figure C5.4-7):

$$V - \omega(x^2) + R_T = 0 \quad (C5.4-31)$$

Figure C5.4-7 Calculating Shear at a Section "x" in the PWF Crawl Space Stud

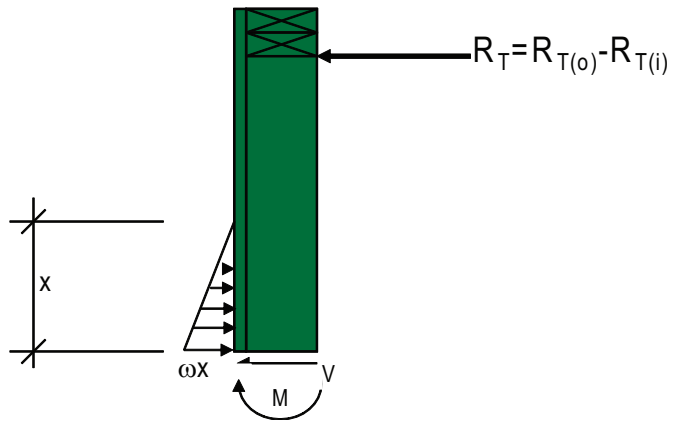

Substituting R_T from equation C5.4-25 into equation C5.4-31 and solving for V gives:

$$V = \frac{\omega(x^2)}{2} - \frac{\omega}{2} \left(\frac{h_o^3 - h_i^3}{3H} \right) \quad (C5.4-32)$$

Setting $V=0$ and solving for x gives the location of the maximum bending moment as follows:

$$x_{max} = \sqrt{\frac{h_o^3 - h_i^3}{3H}} = \sqrt{a} \quad (C5.4-33)$$

Therefore,

$$a = \frac{h_o^3 - h_i^3}{3H} \quad (C5.4-34)$$

[Equation 3 as shown in PWF]

Figure C5.4-8 Shear and Bending Moment for the Portion of Crawl Space PWF Stud Located Above Inside Backfill Height and Subjected to Lateral Forces Due to Outside Backfill Only.

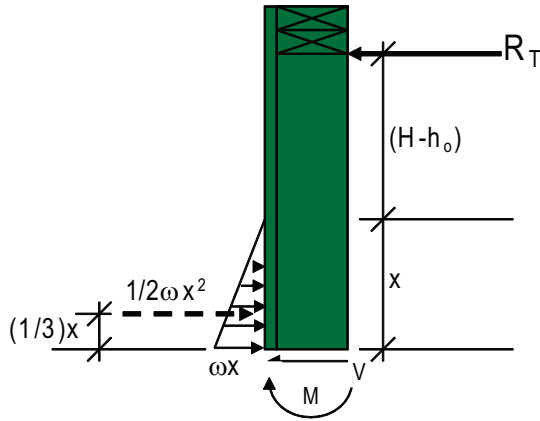

From statics, the sum of moments must equal zero (see Figure C5.4-8):

$$M + R_T(x + H - h_o) - \left(\frac{\omega x^2}{2}\right)\left(\frac{x}{3}\right) = 0 \quad (C5.4-35)$$

Substituting R_T from equation C5.4-25 into equation C5.4-35 and solving for M gives:

$$M = \frac{\omega}{2} \left(\frac{h_o^3 - h_i^3}{3H} \right) (x_{max} + H - h_o) - \frac{\omega x_{max}^3}{6} \quad (C5.4-36)$$

Substituting \sqrt{a} from equation C5.4-33 into equation C5.4-36 gives:

$$M = \frac{\omega a}{2} (H - h_o + \sqrt{a}) - \frac{\omega a \sqrt{a}}{6} \quad (C5.4-37)$$

Simplifying further and multiplying by “s/12” to obtain a bending moment in ft-lbs gives the following:

$$M_{stud} = \frac{\omega a s}{24} \left(H - h_o + \frac{2}{3} \sqrt{a} \right) \quad (C5.4-38)$$

[Equation 4 as shown in PWF]

Figure C5.4-9 Shear and Bending Moment for the Portion of PWF Stud Located Below Inside Backfill Height and Subjected to Lateral Forces Due to Both Outside and Inside Backfill.

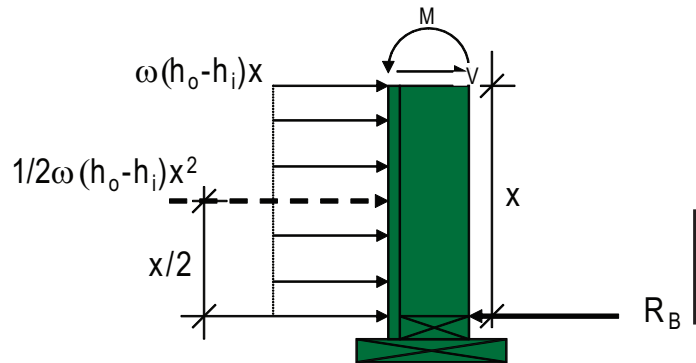

From statics, the sum of horizontal forces must equal zero (see Figure C5.4-9):

$$-V - \omega(h_o - h_i)x + R_B = 0 \quad (C5.4-39)$$

Substituting R_B from equation C5.4-23 into equation C5.4-39 and solving for V gives:

$$V = \frac{\omega}{2} \left(h_o^2 - h_i^2 - \frac{h_o^3 - h_i^3}{3H} \right) - \omega(h_o - h_i)x \quad (C5.4-40)$$

Setting $V=0$ and solving for x gives the location of maximum bending moment:

$$x_{max} = \frac{\frac{1}{2} \left(h_o^2 - h_i^2 - \frac{h_o^3 - h_i^3}{3H} \right)}{h_o - h_i} \quad (C5.4-41)$$

From statics, the sum of moments must equal zero:

$$M + [\omega(h_o - h_i)x] \frac{x}{2} - R_B(x) = 0 \quad (C5.4-42)$$

Substituting R_B from equation C5.4-23 into equation C5.4-42 and solving for M gives:

$$M = \frac{\omega(x_{\max})}{2} \left(h_o^2 - h_i^2 - \frac{h_o^3 - h_i^3}{3H} \right) - \frac{\omega x_{\max}^2}{2} (h_o - h_i) \quad (C5.4-43)$$

Simplifying and multiplying by “s/12” to obtain a bending moment in ft-lb gives the following:

$$M_{stud} = \frac{\omega s (h_o^2 - h_i^2 - a)^2}{96 (h_o - h_i)} \quad (C5.4-44)$$

[Equation 5 as shown in PWF]

C5.4.2 Design of Exterior Wall Sheathing

Basement Walls

The equation for calculating maximum bending moment, M_{panel} , in the exterior foundation wall sheathing for basement walls is based on calculating a maximum uniform lateral soil pressure for the lower-most 12" height of sheathing. However, since the lateral soil load distribution is triangular, a midway point, or 6 inches above the bottom of the sheathing, is used as the basis for the uniformly distributed load.

For single span, two span, and three span conditions, the maximum uniform load based on bending strength can be expressed as follows:

Single span and two span conditions:

$$w_b = \frac{96 F_b K S}{s^2} \quad (C5.4-45)$$

Three span condition:

$$w_b = \frac{120 F_b K S}{s^2} \quad (C5.4-46)$$

where:

w_b = maximum uniform load based on bending strength, psf

F_b = reference bending design value adjusted for wet service conditions and permanent load duration, psi

KS = Effective section modulus for 12 in. width of plywood, in.³/ft

s = center-to-center stud spacing, in.

Expressing it in terms of maximum bending moment due to lateral soil loads gives the following:

Single span and two span conditions:

$$M_{panel} = \frac{\omega s^2 (h - 0.5)}{96} \quad (C5.4-47)$$

Three span condition:

$$M_{panel} = \frac{\omega s^2 (h - 0.5)}{120} \quad (C5.4-48)$$

The only difference between equations C5.4-47 and C5.4-48 is the different value in the denominator. The PWF therefore uses an additional parameter, c , which is equal to 96 for single and two span conditions, and equal to 120 for three span conditions. Therefore one equation can be written as follows:

$$M_{panel} = \frac{\omega s^2}{c} (h - 0.5) \quad (C5.4-49)$$

where:

c = 120 for panels continuous across 3 or more spans, and 96 for panels continuous across two spans or one span.

[Equation 9 as shown in PWF]

Crawl Space Walls

The equation for calculating maximum bending moment, M_{panel} , in the exterior foundation wall sheathing for crawl space walls is based on calculating a maximum uniform lateral soil pressure for the lower-most 12" height of the sheathing. Since the net lateral soil load distribution is uniform in this case, the equation for maximum moment is therefore written as follows:

$$M_{panel} = \frac{\omega s^2}{c} (h_o - h_i) \quad (C5.4-50)$$

where:

c = 120 for panels continuous across 3 or more spans, and 96 for panels continuous across two spans or one span.

[Equation 10 as shown in PWF]

C5.4.3 Design of Top and Bottom Plates

C5.4.3.3 Joints: This wording has been revised from that previously used in *Technical Report 7 - Basic Requirements for the Permanent Wood Foundation System* (5), to more clearly address requirements for staggering joints in top and bottom plates in PWF walls and recognize that joints in the sheathing and lower top plate need to align in prefabricated assemblies.

C5.4.4 Design of Lateral Connections

C5.4.4.1 Top of Wall: Equations for calculation of reaction at the top of the PWF stud wall, R_T , in basement wall studs and crawl space wall studs have been derived previously – see equations C5.4-4 for basement walls and C5.4-25 for crawl space walls.

Note that depending on backfill height and/or lateral soil load, framing straps should be considered to facilitate transfer of load from R_T into the floor joist as shown in Figure C5.4.4.1.

Figure C5.4.4.1 Framing Strap to Transfer Lateral Loads into Floor Joists

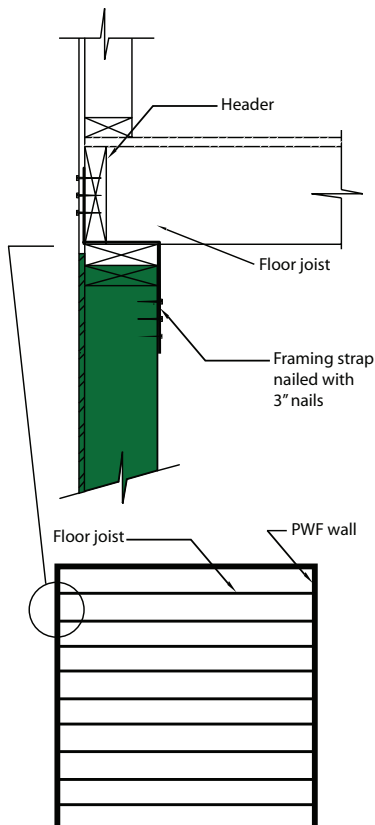

The reaction, R_T , at the top of the wall studs may also be transferred to floor joists by direct bearing of studs on the ends of the joists, or by bearing on a thrust plate which in turn bears on the joists. For such joints, the studs and thrust plate are evaluated for adequacy of compression stress perpendicular to grain where appropriate.

C5.4.4.2 Bottom of Wall: Equations for calculation of reaction at the bottom of the PWF stud wall, R_B , in basement wall studs and crawl space wall studs has been derived previously – see equations C5.4-5 for basement walls and C5.4-23 for crawl space walls.

Note that a partially excavated crawl space wall assembly does not have a basement floor system at the bottom of the wall to provide resistance to net inward soil forces at that location. For those cases where the difference in backfill height ($h_o - h_i$) is relatively insignificant, it can be assumed that the net lateral inward force at the bottom can be resisted by friction between the footing plate and granular footing below. Otherwise additional methods of restraint may be required, such as by use of a concrete slab as illustrated in Figure C5.4.4.2.

Figure C5.4.4.2 Concrete Slab to Resist Lateral Forces at the Bottom of a Crawl Space Wall

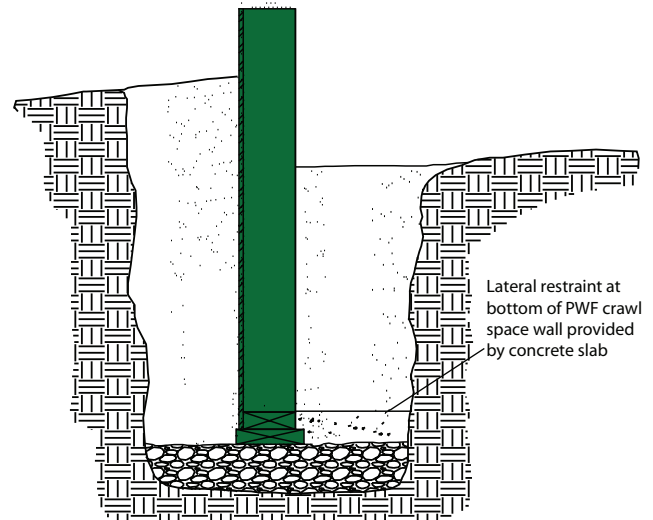

C5.4.5 Design for In-Plane Shear

Since nominal unit shear capacities for shear walls and diaphragms published in the *Special Design Provisions for Wind and Seismic (SDPWS)* Specification (4) are based on short-term load duration, it is necessary to multiply nominal unit shear capacities for seismic by 0.281. The 0.281 multiplier results from the combination of the 2.0 allowable stress design (ASD) reduction factor and a 0.9/1.6 factor for adjusting from the ten-minute load



duration basis for wind and seismic design in the *SDPWS* to a permanent load duration basis for PWF applications.

C5.4.5.1 Induced Lateral Load Due to Differential Backfill Height: Note that Equation 15 for B_s in the *PWF* is equal to the net reaction at the top of the wall with the higher backfill as shown in Figure C5.4.5.1.

C5.4.5.5 Design for Uplift and Overturning: The overturning moment acting on the permanent wood foundation due to lateral loads as well as the resisting moment due to the structure's own dead load should be calculated using standard engineering practice.

C5.4.5.5.1 Anchorage: Connection capacity for a spike embedded in concrete as shown in Figures 5 and 6 in the *PWF* can be determined using yield limit equations provided in Chapter 11 of the *NDS*, similar to that computed for bolts as shown in Table 11E in the *NDS*.

Figure C5.4.5.1 Net Resultant of Forces Due to Differential Backfill Height

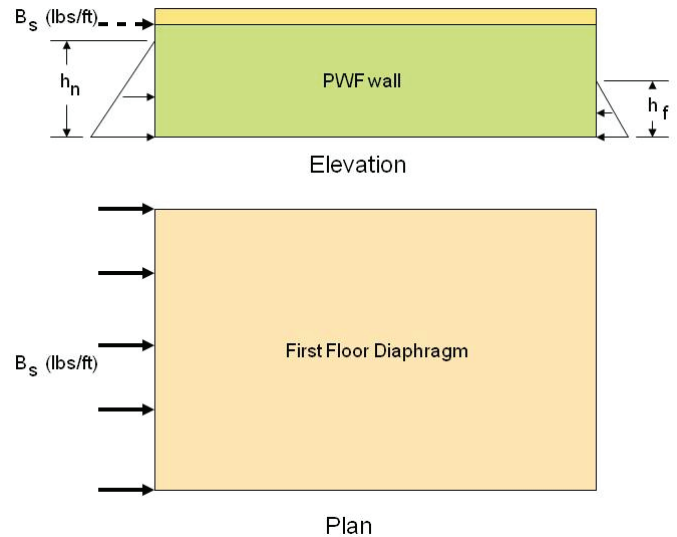

C5.5 Footing Design

C5.5.2 Composite Footings

C5.5.2.1 Width: Prior to *PWF*, calculation for minimum width or area of a wood footing plate as shown in Equations 16 and 17, incorporated a prescriptive value for minimum allowable bearing pressure between the footing plate and gravel or crushed stone footing, equal to 3000 psf. *PWF* is more general and uses the variable “ q_{footing} ” instead.

C5.5.2.2 Tension Perpendicular to Grain: Footing plate design provisions in the *PWF* assume that the adjusted ASD tension perpendicular to grain stress, F'_{tL} , is approximately one-sixth of the adjusted shear design value, F'_v , from the 2001 and later editions of the *NDS*.

Wood footing plates of nominal 2" thickness generally will not possess sufficient tension perpendicular to grain strength to carry applied axial loads when the footing plate width is more than 2" wider than the bottom wall plate above it. In such cases, a thicker footing plate may be used or substituted with multiple layers of plywood of sufficient width and strength. Alternatively, plywood may also be used to reinforce the 2" footing plate as shown in Figure C5.5.2.2-1.

Figure C5.5.2.2-1 Plywood Reinforcing Strip

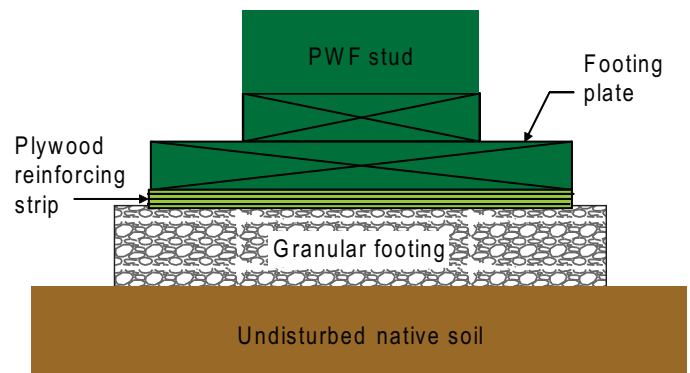
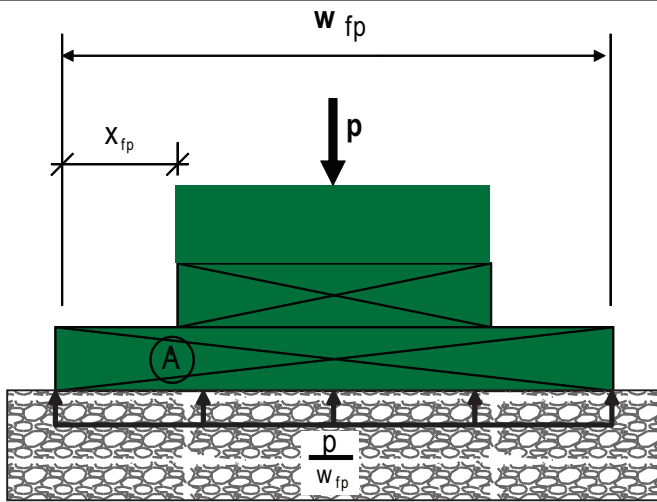

Figure C5.5.2.2-2 shows the forces acting on the cantilevered portion of the footing plate. The equation for calculation of induced ASD design bending moment can therefore be derived from statics by summing moments about point “A” as follows:

Figure C5.5.2.2-2 Forces on Cantilevered Portion of Footing Plate



$$-M_{fp} + \frac{px_{fp}}{w_{fp}} \left(\frac{x_{fp}}{2} \right) = 0 \quad (C5.4-51)$$

$$M_{fp} = \frac{p(x_{fp})^2}{2w_{fp}} \text{ (in.-lbs)/ft (ft of plate)} \quad (C5.4-52)$$

[Equation 19 as shown in PWF]

C5.5.3 Bearing Stress on Soil

The axial load from the wood footing plate is assumed to be distributed outward through the gravel, coarse sand, or crushed stone footing at an angle of 30 degrees from the vertical at each edge of the wood footing plate as shown in Figure C5.5.3.2-1.

Figure C5.5.3.2-1 Distribution of Axial Load from Wood Footing Plate

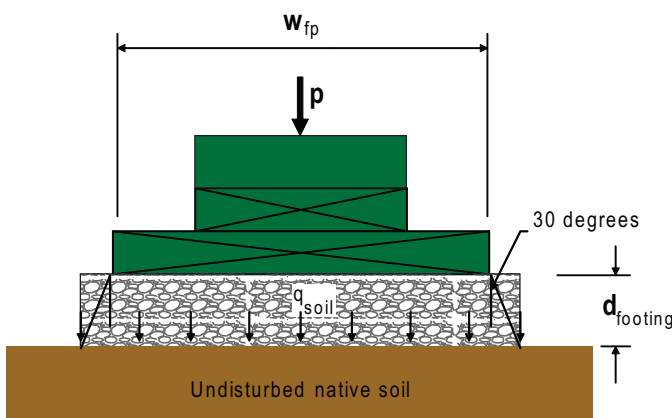

C5.5.3.2(a) Footing Supporting a Wall: Bearing stress on the soil, q_{soil} , from a footing supporting a wall is derived by taking the axial load, p , and dividing by the width over which the load acts on the soil ($w_{fp} + 2d_{footing} \tan 30^\circ$).

Since w_{fp} and $d_{footing}$ are expressed in terms of inches, and the axial design load, p , is expressed in lbs/ft, the numerator is multiplied by 12 so that q_{soil} is expressed in psf.

$$q_{soil} = \frac{12p}{w_{fp} + 2d_{footing} \tan 30^\circ} \quad (C5.4-53)$$

where:

p = axial ASD design load, lbs /ft

w_{fp} = width of wood footing plate, in.

$d_{footing}$ = depth of granular footing, in.

q_{soil} = induced bearing pressure on soil, lbs /ft²

[Equation 20 as shown in PWF]

Substituting the minimum granular footing depth, $d_{footing} = 0.75w_{fp}$ into equation C5.4-53, gives the following:

$$q_{soil} = \frac{6.43p}{w_{fp}} \quad (C5.4-54)$$

Using a minimum allowable bearing pressure between the wood footing plate and granular drainage layer, $q_{footing} = 3000$ psf, the minimum wood footing plate width is calculated as follows:

$$w_{fp} = \frac{12p}{q_{footing}} = \frac{12p}{3000} = \frac{p}{250} \quad (C5.4-55)$$

Substituting equation C5.4-55 into C5.4-54, the corresponding induced bearing pressure on the soil can be calculated as follows:

$$q_{soil} = \frac{6.43p}{w_{fp}} = \frac{6.43p}{\frac{p}{250}} = 1608 \text{ lbs/ft}^2 \quad (C5.4-56)$$

Therefore, where the minimum w_{fp} is equal to $p/250$, q_{soil} will be equal to 1608 psf, which is considerably less than allowable bearing pressures for Group I-III soils. Thus, footing designs are normally limited by the allowable bearing stress of the wood footing plate on the gravel, coarse sand, or crushed stone footing rather than by the allowable soil bearing pressure. Occasionally, allowable bearing on the soil, q_{soil} , is low enough to govern footing



design. Minimum thickness of the granular footing is therefore calculated as follows:

Re-arranging equation C5.4-53:

$$d_{\text{footing}} = \frac{1}{2 \tan 30^\circ} \left(\frac{12p}{q_{\text{soil}}} - w_{\text{fp}} \right) \quad (\text{C5.4-57})$$

$$= 0.87 \left(\frac{12p}{q_{\text{soil}}} - w_{\text{fp}} \right)$$

C5.5.3.2(b) Footing Supporting Posts and Piers: Bearing stress on the soil, q_{soil} , from a footing supporting posts and piers is derived by taking the axial load, p , and dividing by the area over which the load acts on the soil $(w_{\text{fp}} + 2d_{\text{footing}} \tan 30^\circ) (\ell_{\text{fp}} + 2d_{\text{footing}} \tan 30^\circ)$.

Since w_{fp} , ℓ_{fp} , and d_{footing} are expressed in terms of inches, and the axial design load, p , is expressed in pounds, the numerator is multiplied by 144 in.² allowing q_{soil} to be expressed in psf.

$$q_{\text{soil}} = \frac{144p}{(w_{\text{fp}} + 2d_{\text{footing}} \tan 30^\circ) (\ell_{\text{fp}} + 2d_{\text{footing}} \tan 30^\circ)} \quad (\text{C5.4-58})$$

where:

q_{soil} = induced bearing pressure on soil from footing, lbs/ft²

w_{fp} = width of wood footing plate, in.

ℓ_{fp} = length of wood footing plate, in.

d_{footing} = depth of granular footing, in.

p = axial ASD design load, lbs

[Equation 21 as shown in PWF]

Where a spread footing is used to support posts or piers, the footing can be designed to avoid tension perpendicular to grain stresses by using a system of alternating planks as shown in Figure C5.5.3.2-2. When this configuration is used, each alternating plank layer should be designed to minimize deflection of the loaded planks. An increasing number of layers can be used to achieve the desired bearing area.

Figure C5.5.3.2-2 Spread Footing Using Alternating Layers of Wood Planks

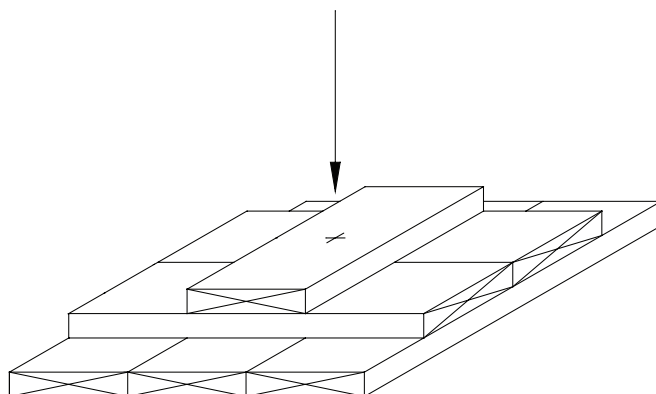

C5.6 Basement Floor Design

C5.6.2 PWF Basement Floors

C5.6.2.2 Lateral Soil Load Transfer: All lumber and plywood framing utilized in PWF basement floors shall be preservative treated and conform to *AWPA U1* (6).

Figure C5.6.2.2 illustrates blocking requirements for end walls where joists run parallel to the PWF wall. Full depth blocking, increased nailing, and additional framing members are needed between the first two floor joists to transfer lateral soil loads from the PWF end wall studs into the subfloor, as illustrated in Figure C5.6.2.2.

Figure C5.6.2.2 Blocking for PWF End Walls

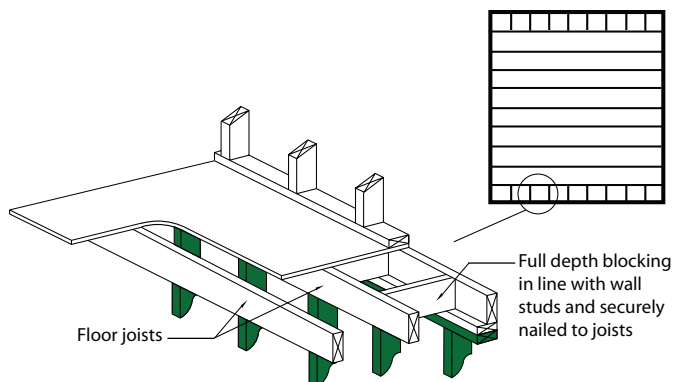

REFERENCES

1. ASCE/SEI 7-05, Minimum Design Loads for Buildings and Other Structures, American Society of Civil Engineers, Reston, VA, 2005.
2. ASTM F1667-05, Standard Specification for Driven Fasteners: Nails, Spikes, and Staples, ASTM, West Conshohocken, PA, 2005.
3. ANSI/AF&PA NDS-2005 National Design Specification (NDS) for Wood Construction, American Forest & Paper Association (AF&PA), Washington, DC, 2005.
4. ANSI/AF&PA SDPWS-2008 Special Design Provisions for Wind and Seismic (SDPWS), American Forest & Paper Association (AF&PA), Washington, DC, 2008.
5. AF&PA T.R. No. 7-87, Technical Report – Basic Requirements for Permanent Wood Foundation System, American Forest & Paper Association (AF&PA), Washington, DC, 1987.
6. AWPA, U1-06, Use Category System: User Specification for Treated Wood (Use Category 4B: Permanent Wood Foundations), American Wood Protection Association, Birmingham, AL, 2006.
7. International Building Code (IBC), International Code Council, Falls Church, VA, 2006.
8. Permanent Wood Foundation System, Design, Fabrication, Installation (DFI) Manual, American Forest & Paper Association (AF&PA), Washington, DC, 1987.
9. CAN/CSA-S406-92, Construction of Preserved Wood Foundations, Canadian Standards Association, Etobicoke, ON, Canada, 1992.



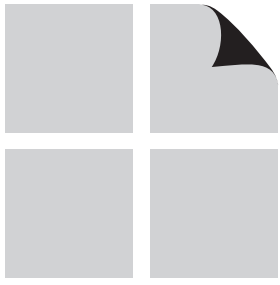

American Wood Council

Engineered and Traditional Wood Products

AWC Mission Statement

To increase the use of wood by assuring the broad regulatory acceptance of wood products, developing design tools and guidelines for wood construction, and influencing the development of public policies affecting the use of wood products.

**American Forest & Paper Association
American Wood Council
1111 19th Street, NW
Suite 800
Washington, DC 20036
www.awc.org
awcinfo@afandpa.org**

***America's Forest & Paper People[®]
Improving Tomorrow's Environment Today[®]***



ISBN 0-9786245-8-0



9

7 8 0 9 7 8 6 2 4 5 8 3

03-09